

PARTITIONS

DOORS & SYSTEMS

Doors for your home

HOSET

Hoset is a company that offers a choice of entrance and interior doors, sliding systems, furniture, and interior items. Partitions is an innovative solution for the internal space division of the premises without construction of the capital walls.

An application of the modern technologies and materials provide endless possibilities for the arrangement of the residential spaces, offices, business centers, exhibition and trade halls.

Aluminum and glass, HPL, MDF and veneer panels, combined with the functional sliding and swing systems are unique materials for creation of the architectural and design projects.

SPACE WITHOUT BORDERS

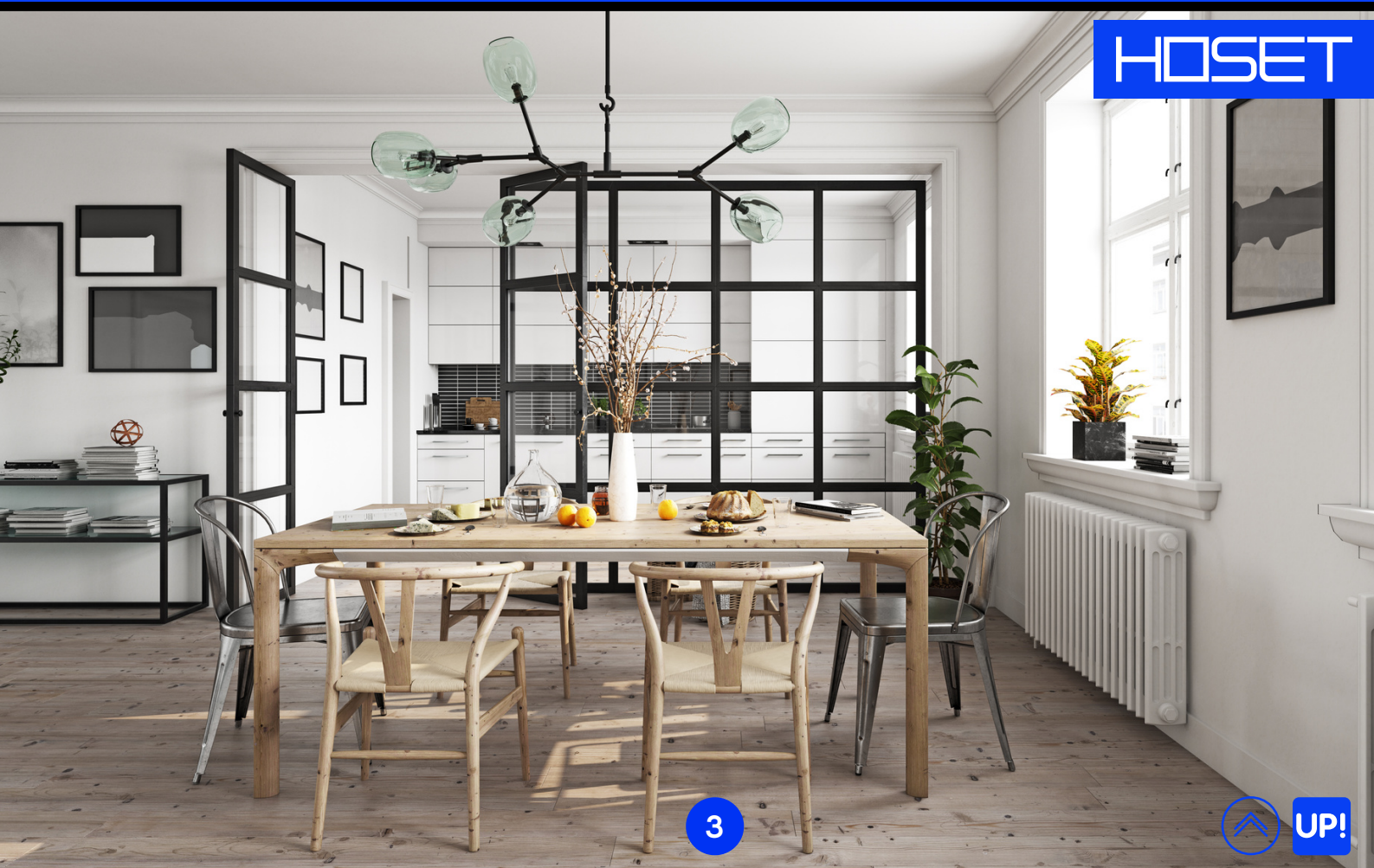

HOSET

CONTENT

Types of the partitions	13
Joints of the partition elements	17
Partitions with the sliding system	25
Partitions with the all-glass sliding system	29
Variants of the swing door leaves in the partitions	33
Variants of the sliding door leaves in the partitions	37
Profile color	41
Glass variants	42



CONTENT



















Linear partition

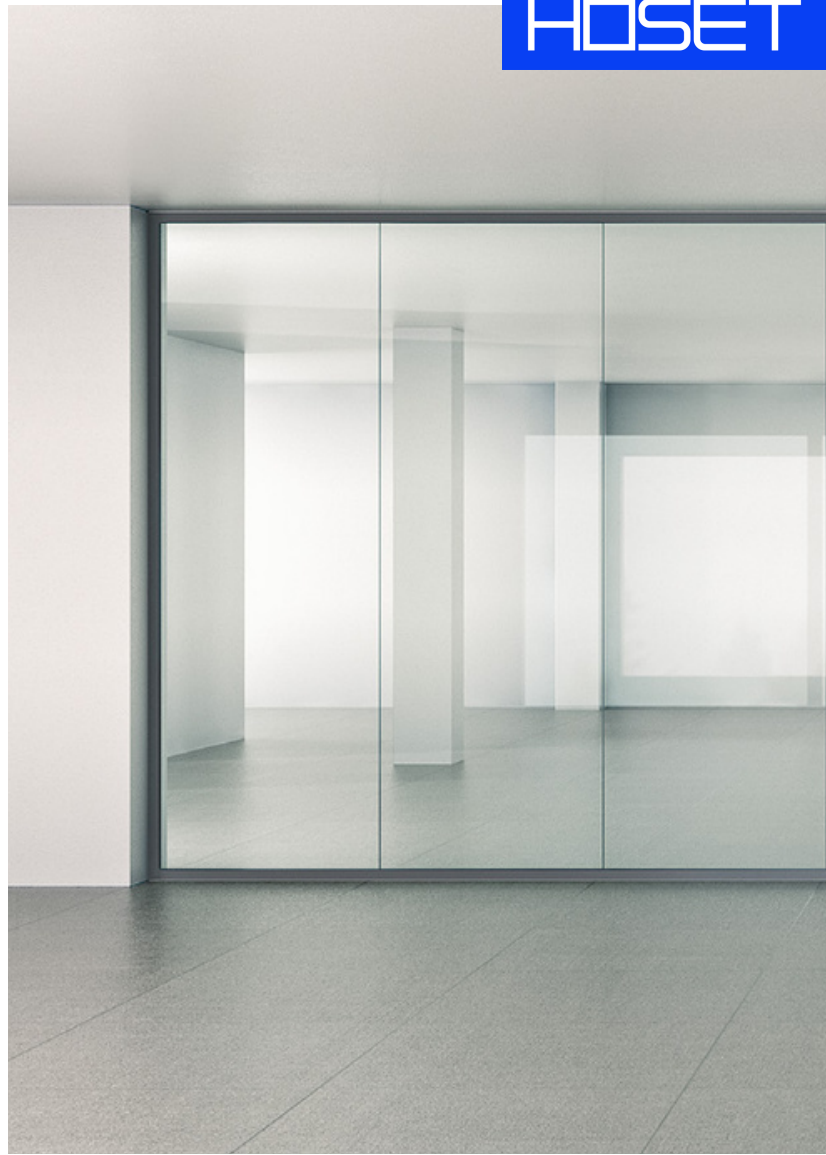
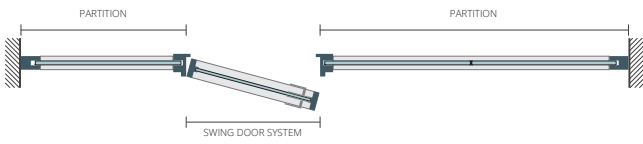

PARTITION TYPES

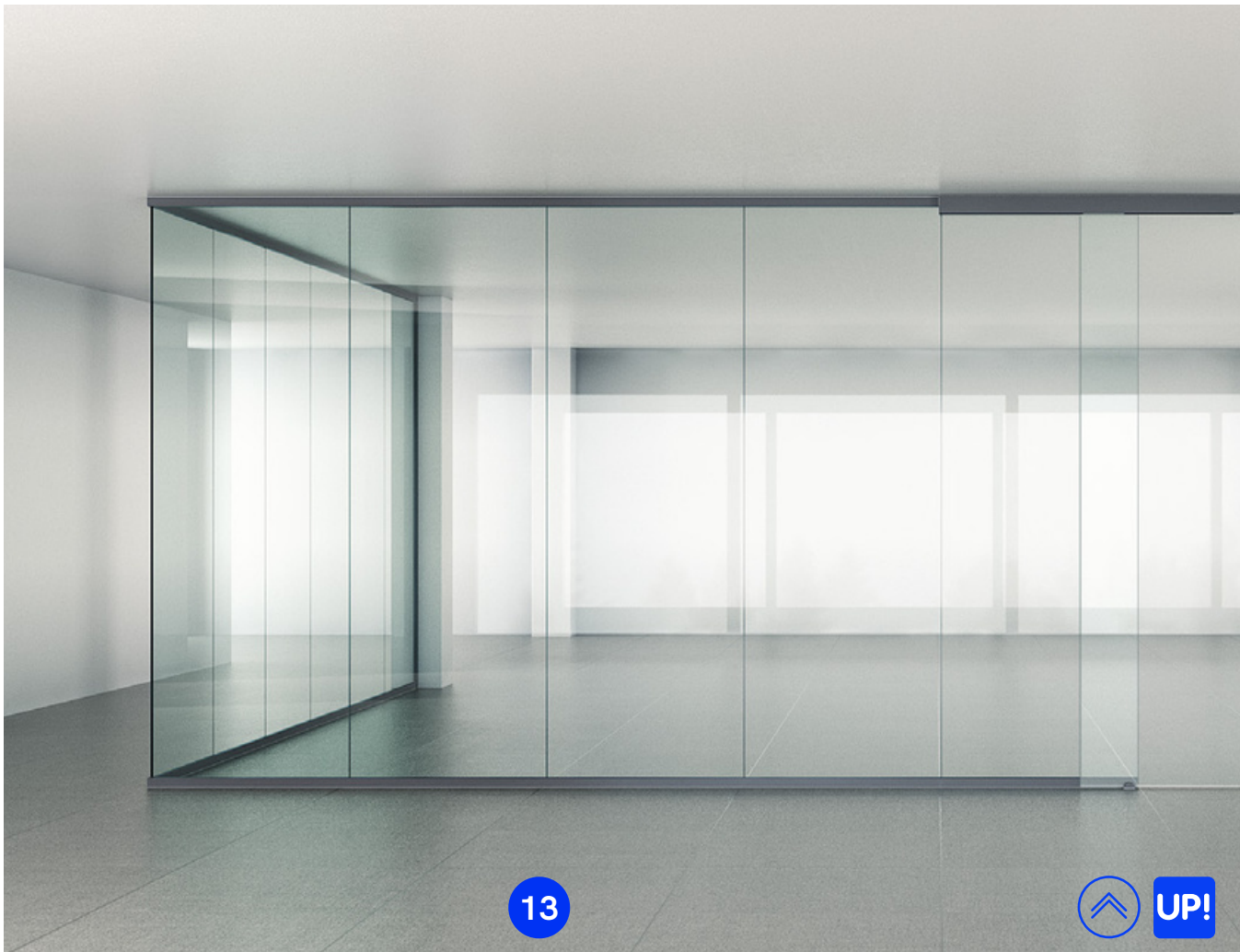

PARTITION TYPES



L-shaped partition

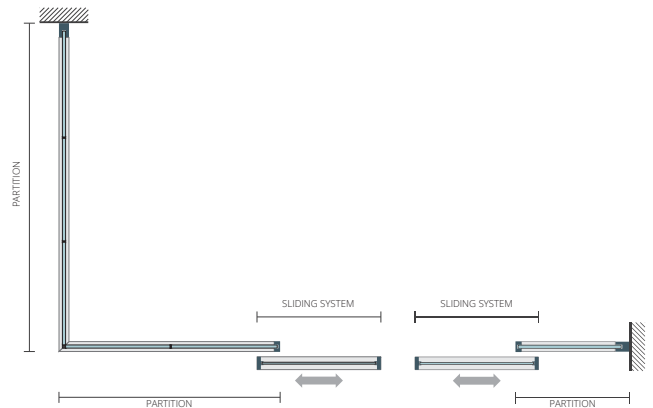



O-Shaped partition

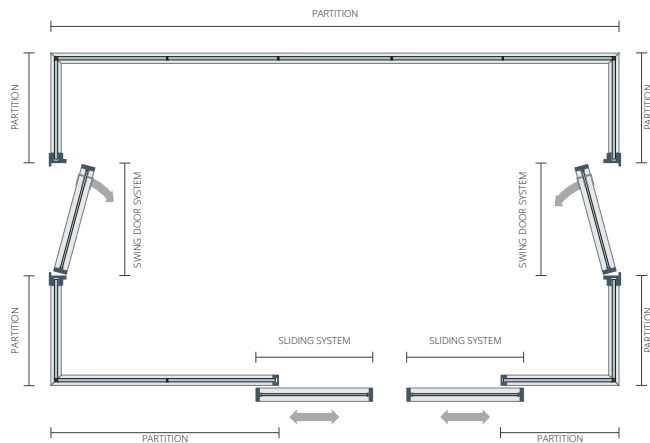

C-Shaped partition

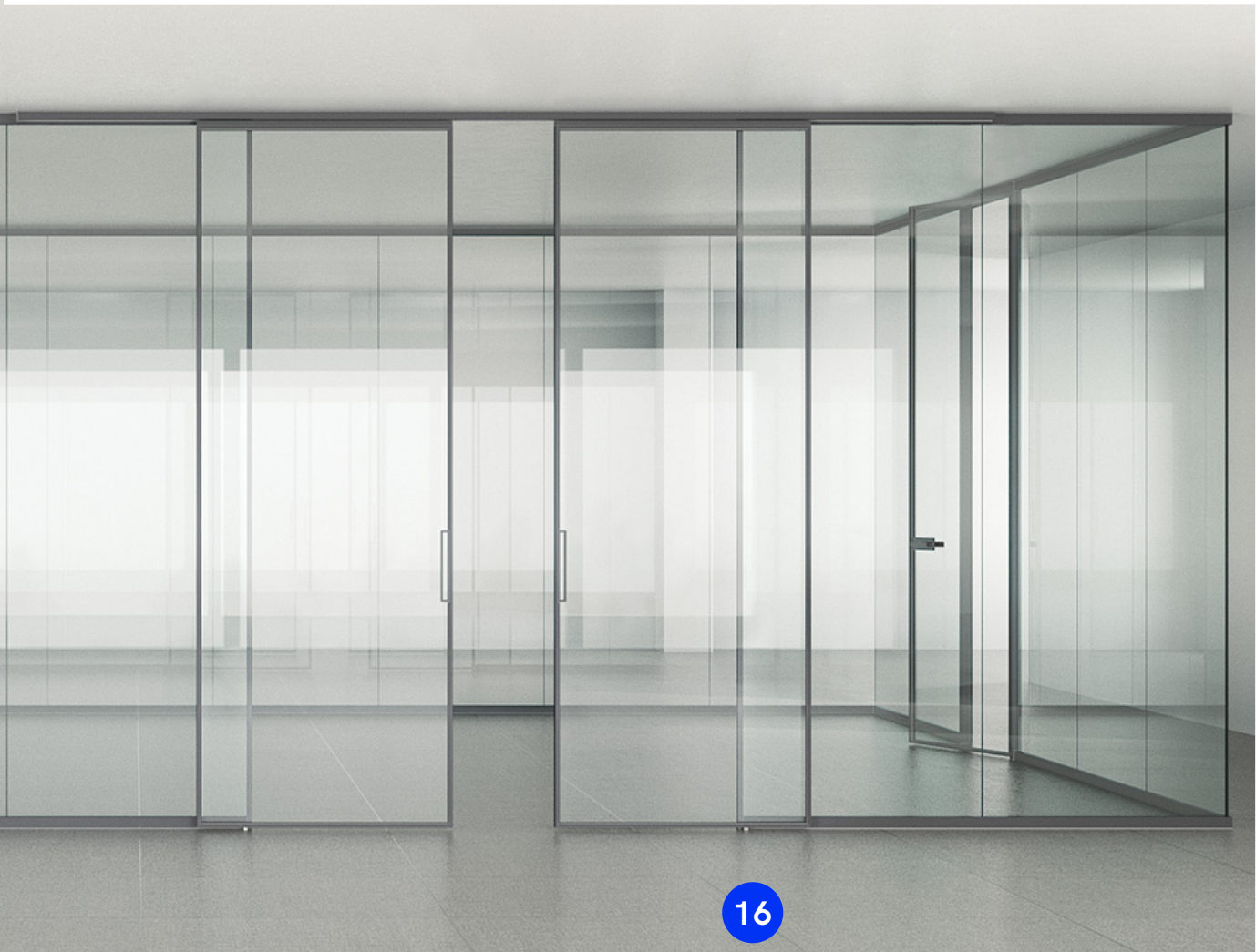
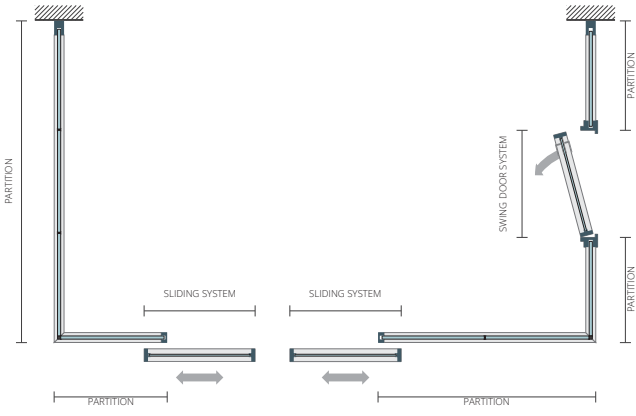

PARTITION TYPES

JOINTS OF THE PARTITION ELEMENTS



1 JOINT 90°



2 T-SHAPED JOINT

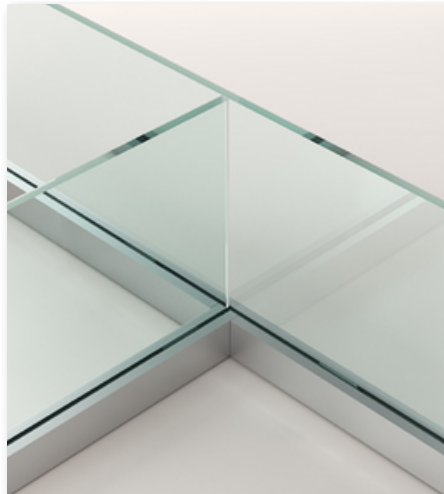

3 X-SHAPED JOINT





4 WALL PARTITION ABUTMENT



5 WALL AND DOOR FRAME JOINT



6 GLASS PANELS JOINTS



1. GLASS PANEL JOINT

LINEAR FLAT PARTITION

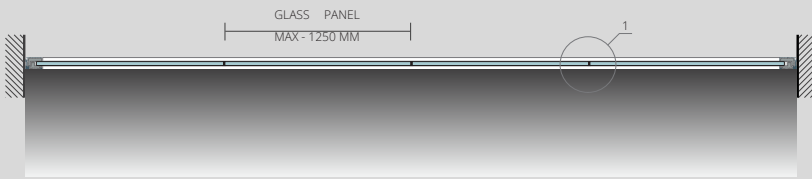

LINEAR PARTITION WITH THE SLIDING/SWING SYSTEM

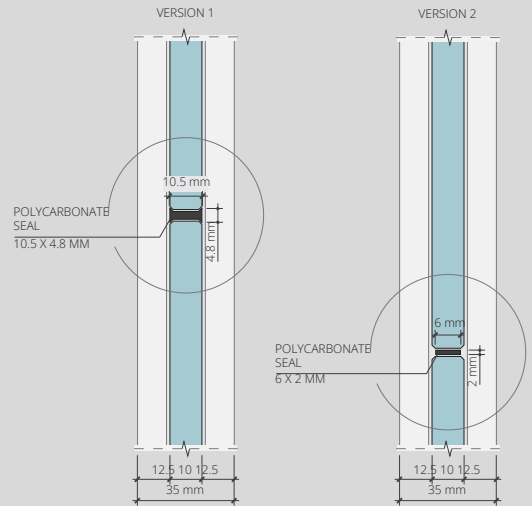
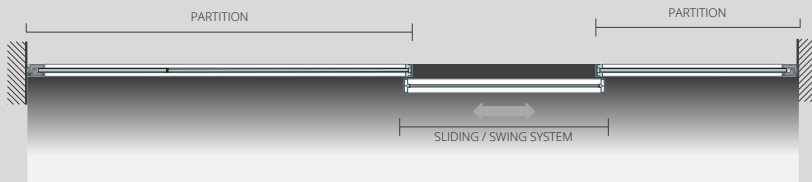

L-SHAPED FLAT PARTITION

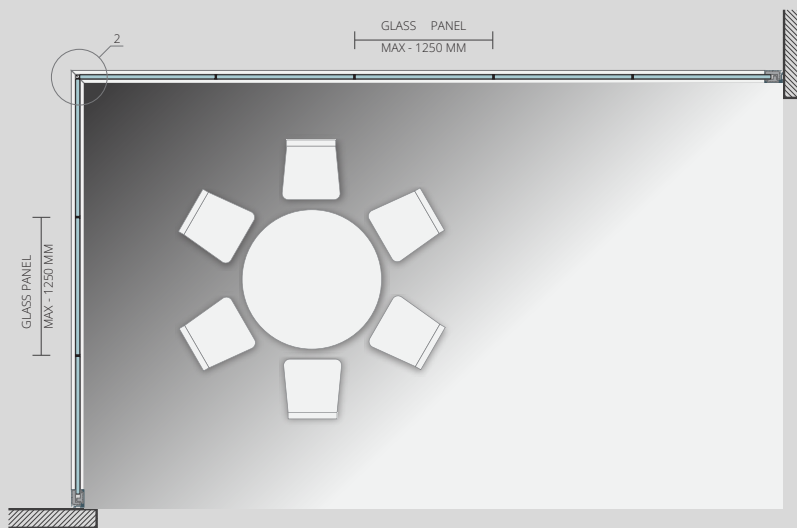

2. ANGLE JOINT JUNCTION

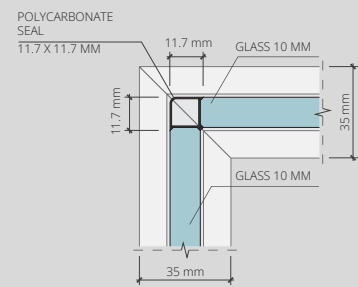

L-SHAPED PARTITION WITH THE SLIDING/SWING SYSTEM

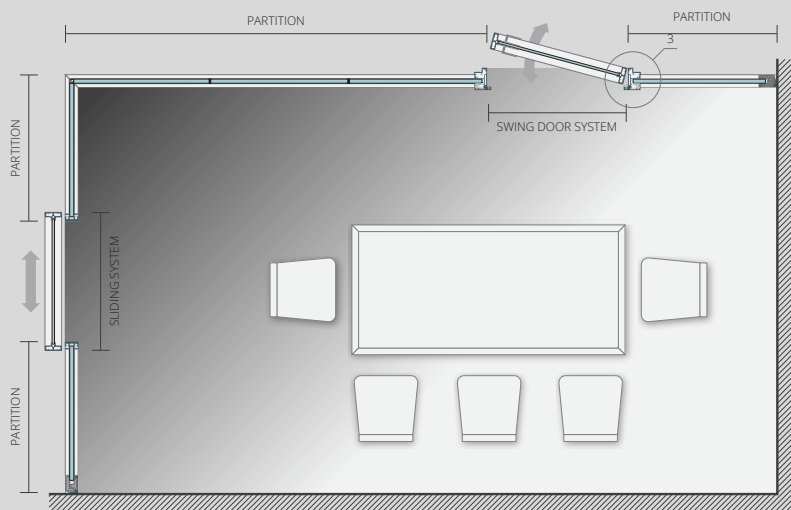

3. DOOR LEAF AND PARTITION JUNCTION

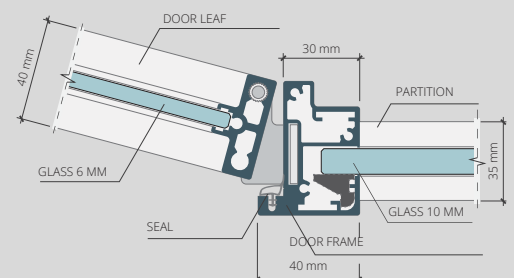

C-SHAPED FLAT PARTITION

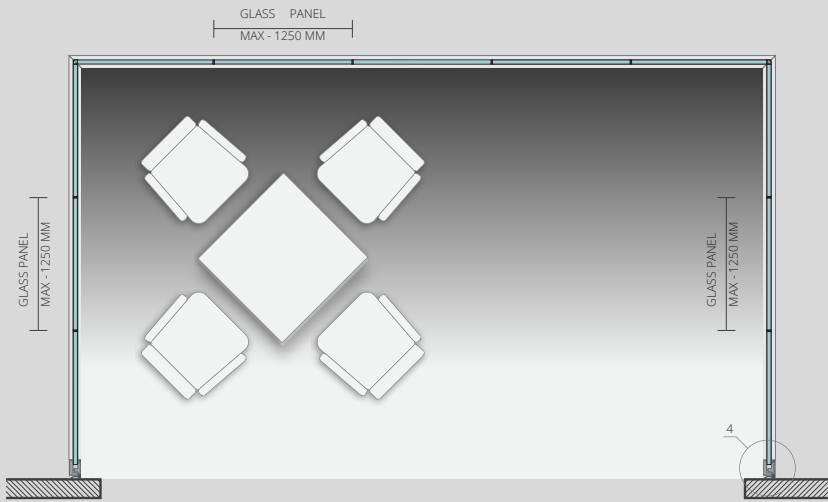

4. JUNCTION OF THE PARTITION TO THE WALL

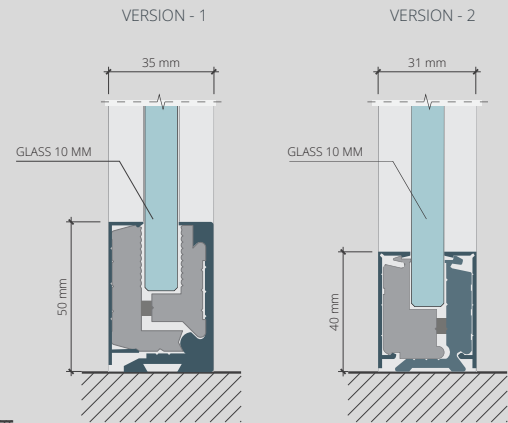

C-SHAPED PARTITION WITH THE SLIDING/SWING SYSTEMS

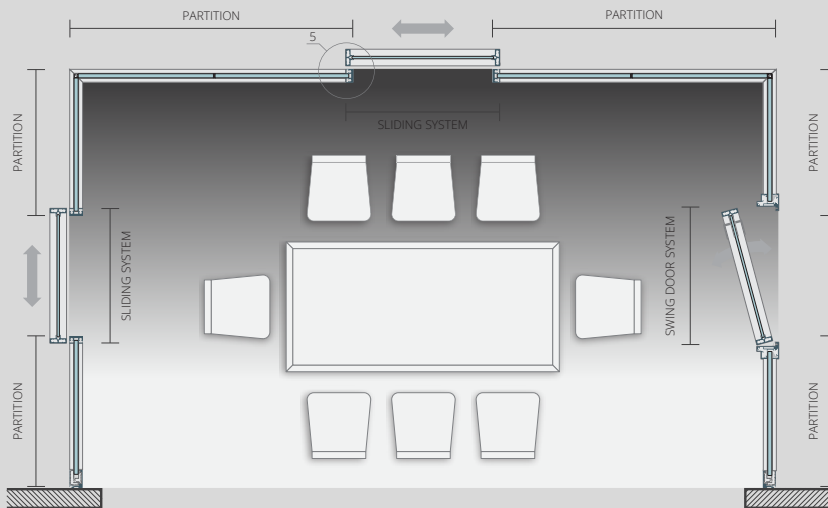

5. JUNCTION OF THE DOOR LEAF AND PARTITION

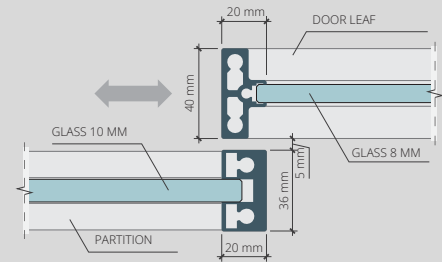

O-SHAPED PARTITION WITH THE SWING/SLIDING SYSTEMS

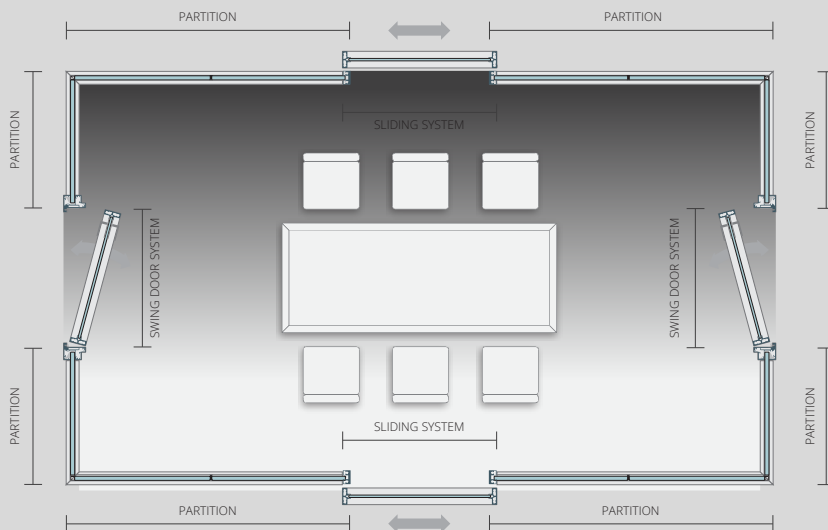

DOOR LEAF WITH TRANSOM



HORIZONTAL SECTION

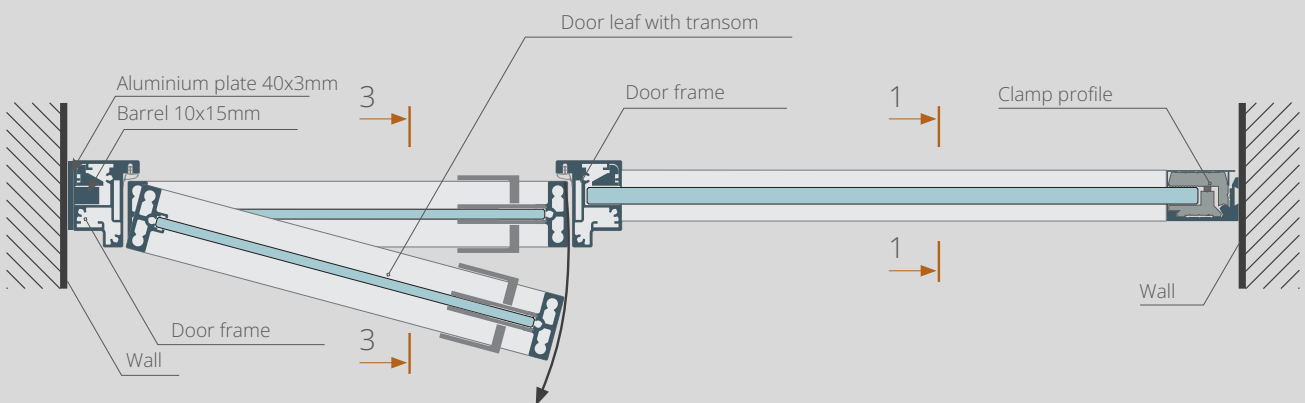
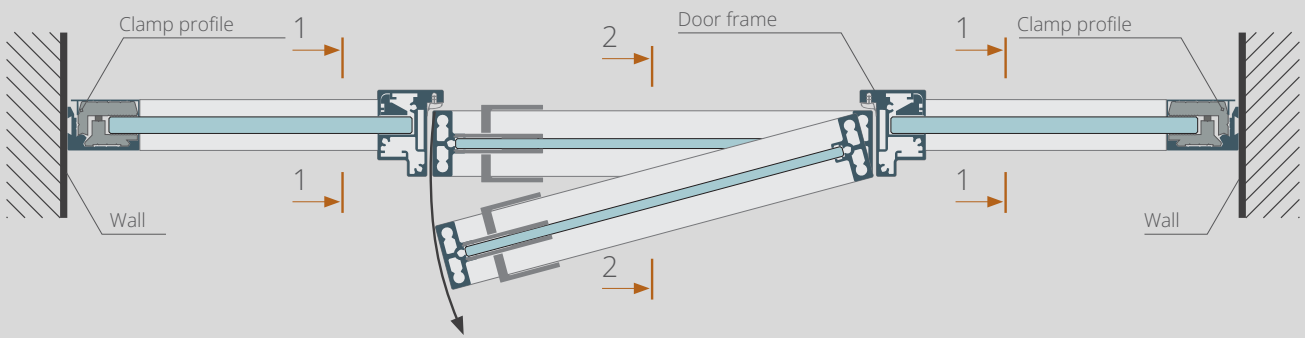
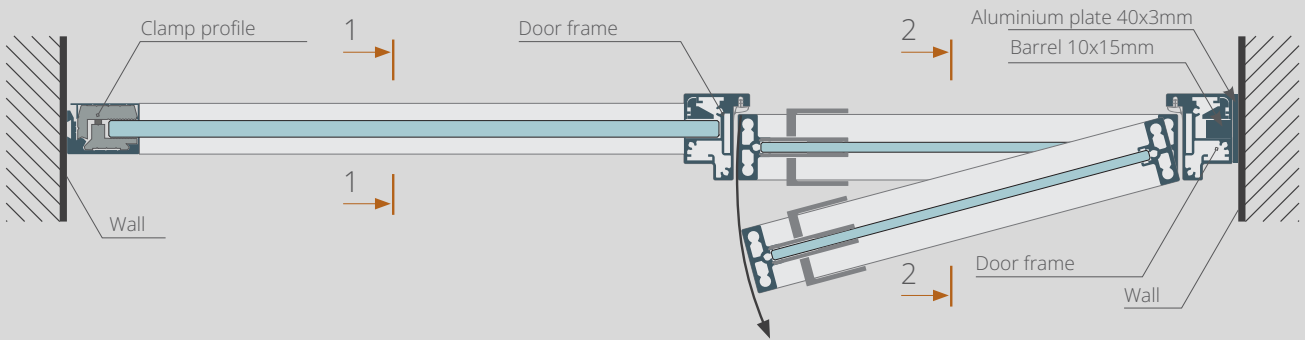

VERTICAL SECTION

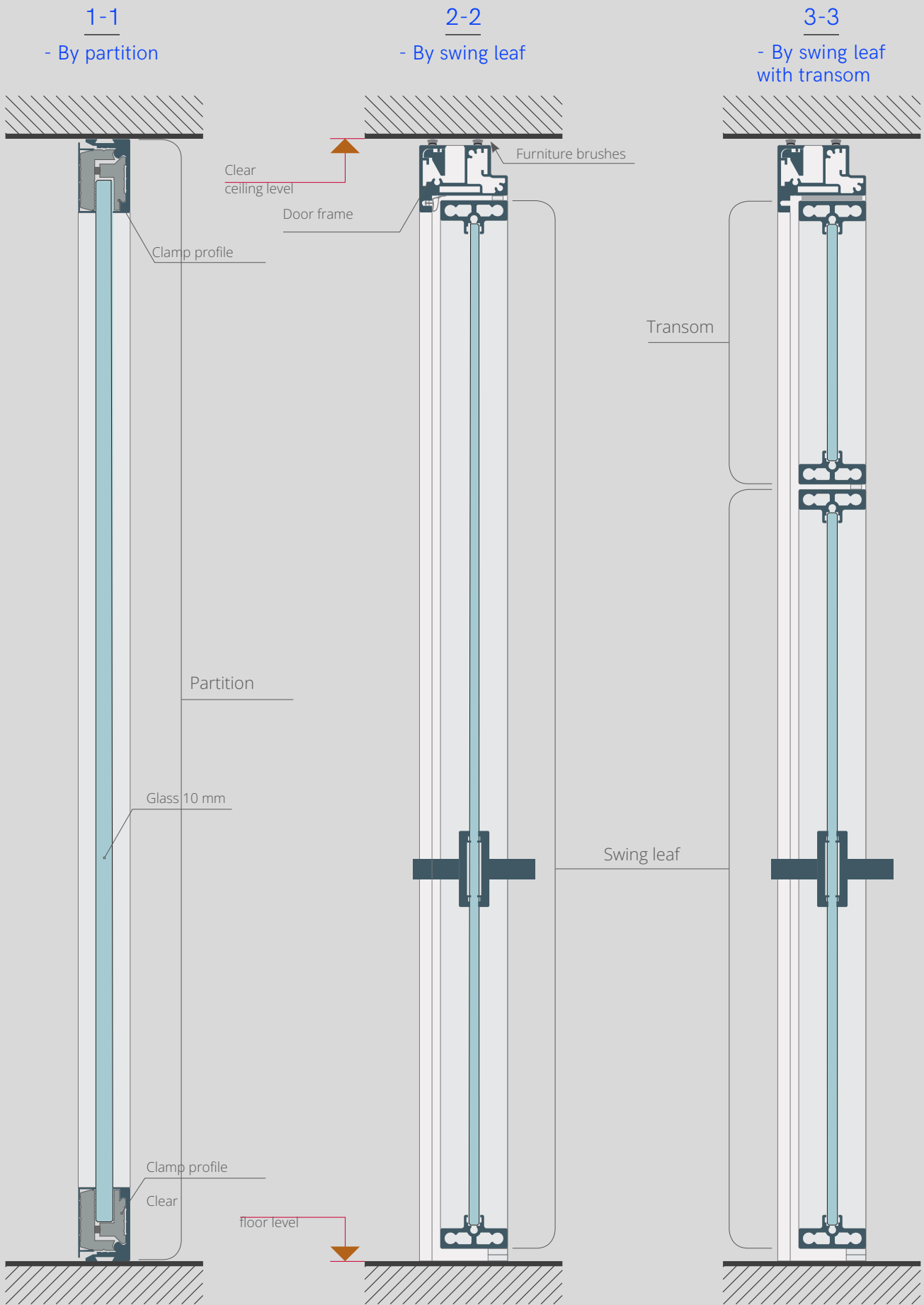

ALU 1 PROFILE IN THE CONCEALED SYSTEM

Partition
with sliding system

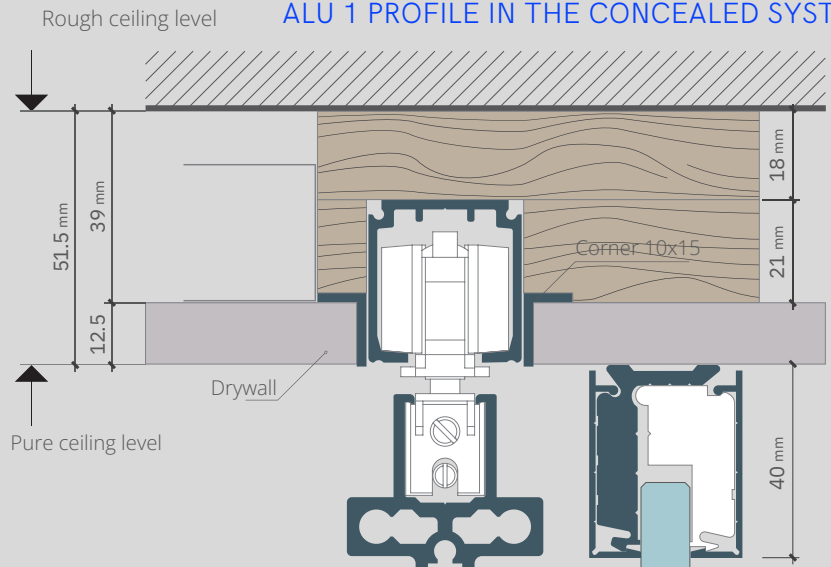

Hafele SLIDO CLASSIC - I system

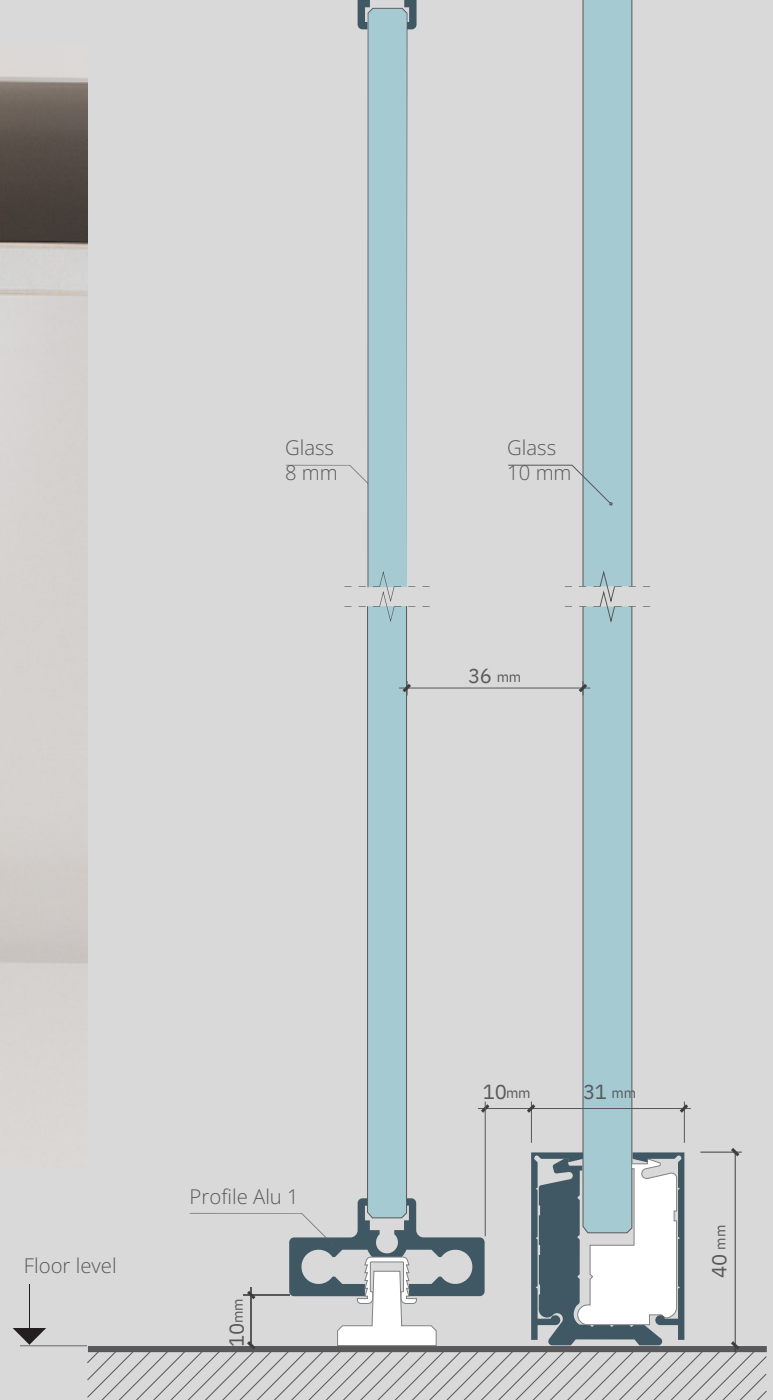



Hafele SLIDO CLASSIC - I system

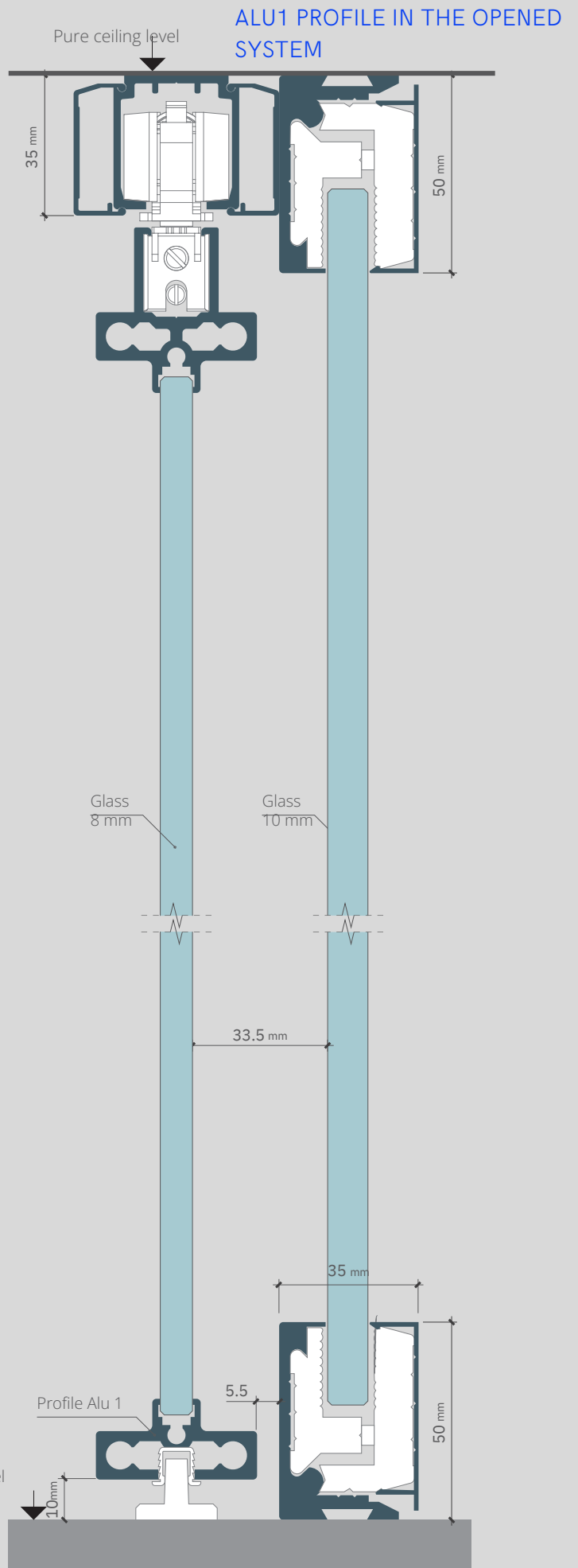

ALU 2 PROFILE IN THE CONCEALED SYSTEM

Partition
with sliding system

Hafele SLIDO CLASSIC - I system





Hafele SLIDO CLASSIC - I system

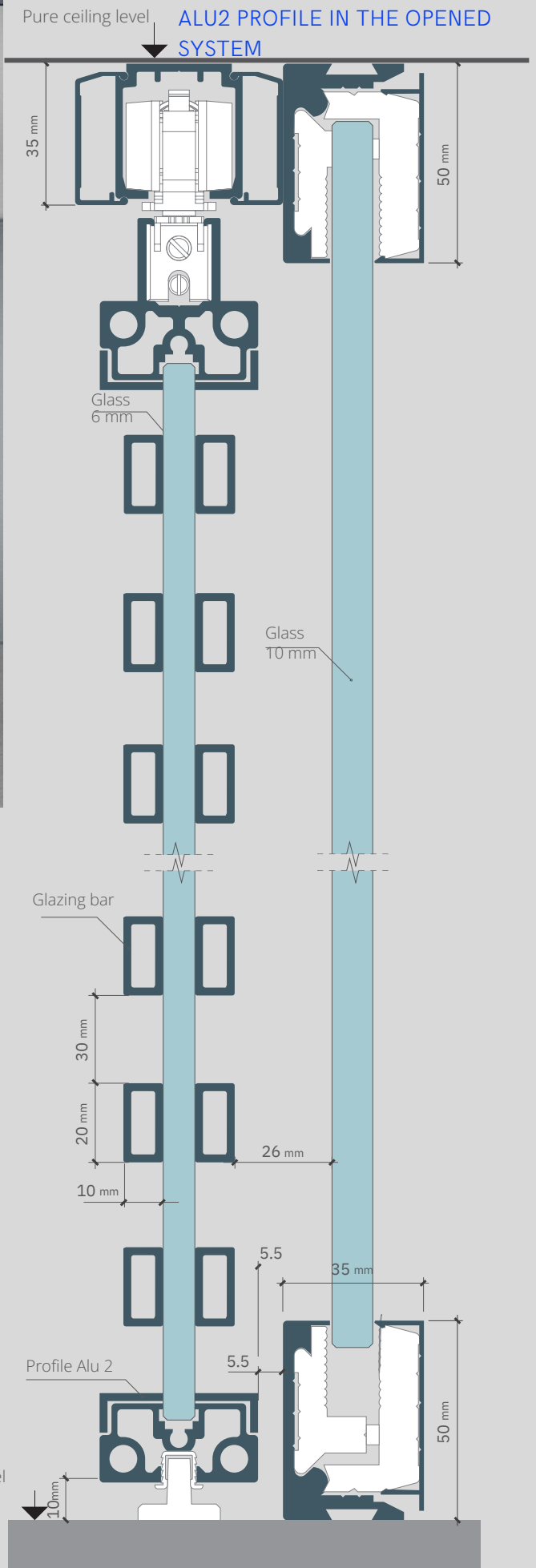

Partition with sliding system

Hafele SLIDO CLASSIC - I system

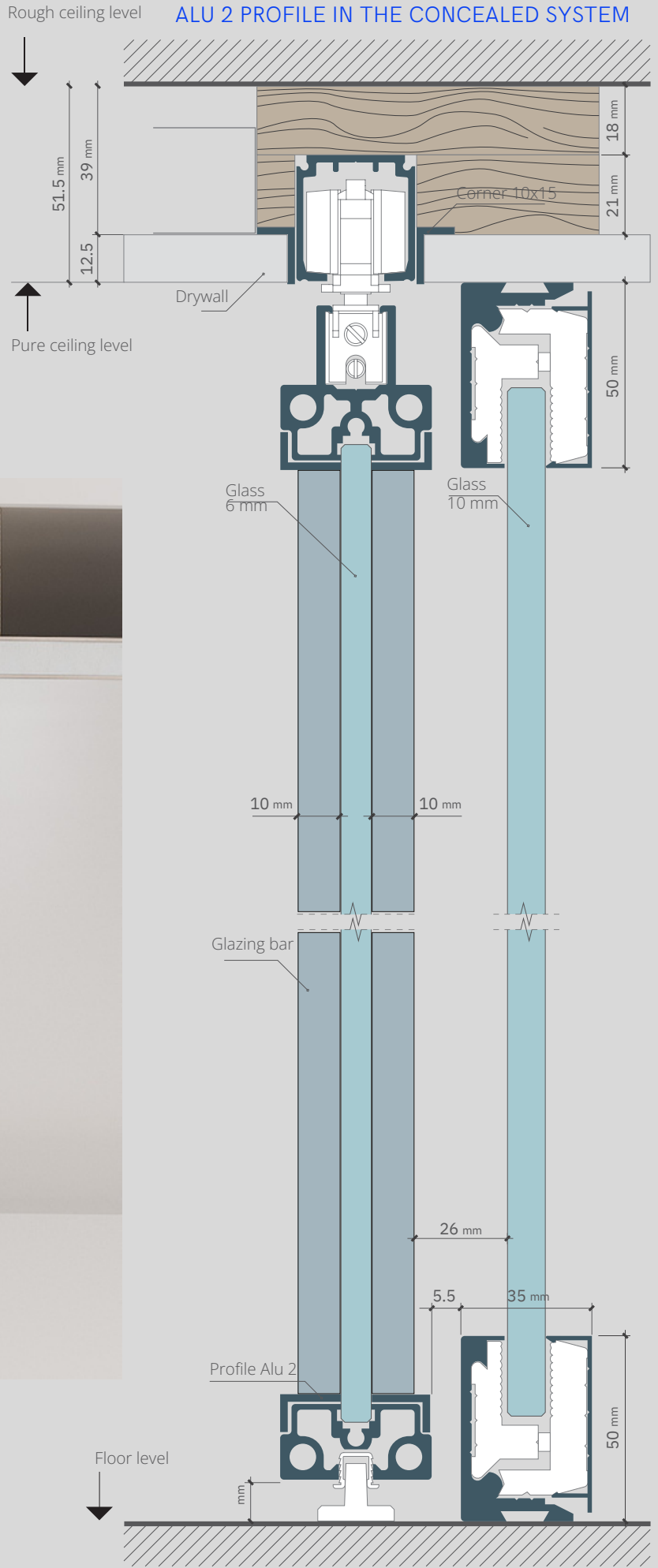



Hafele SLIDO CLASSIC - I system

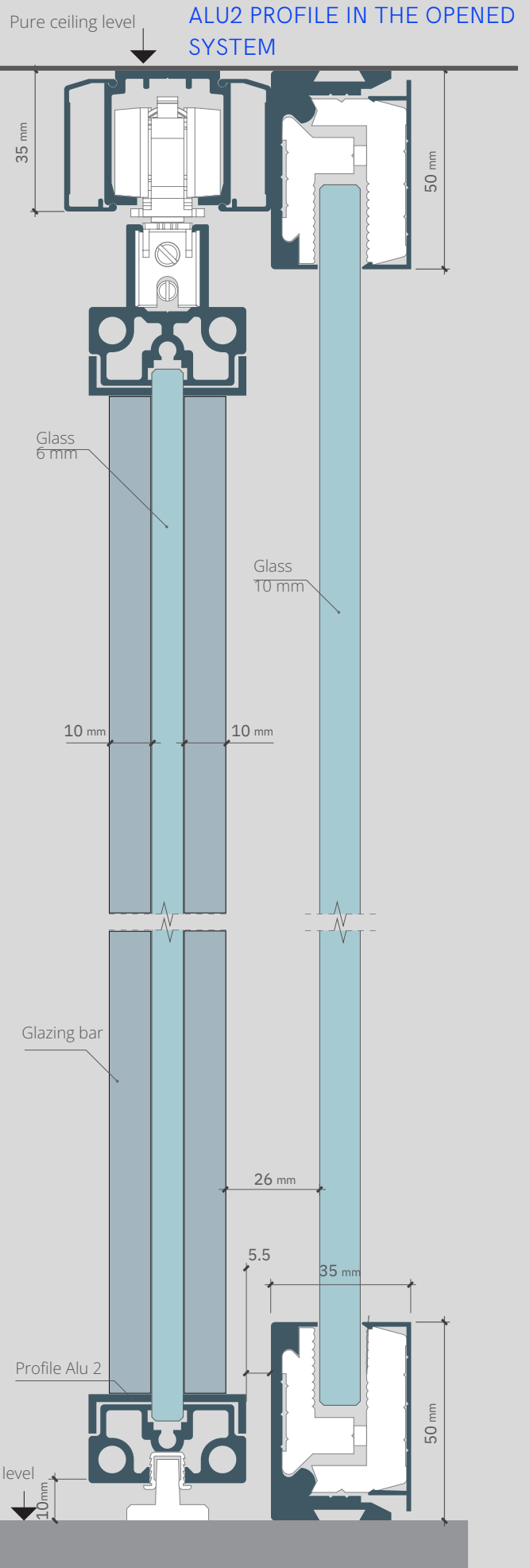

SOLID GLASS DOOR LEAF IN THE CONCEALED SYSTEM

Partition
with full-glass
sliding system

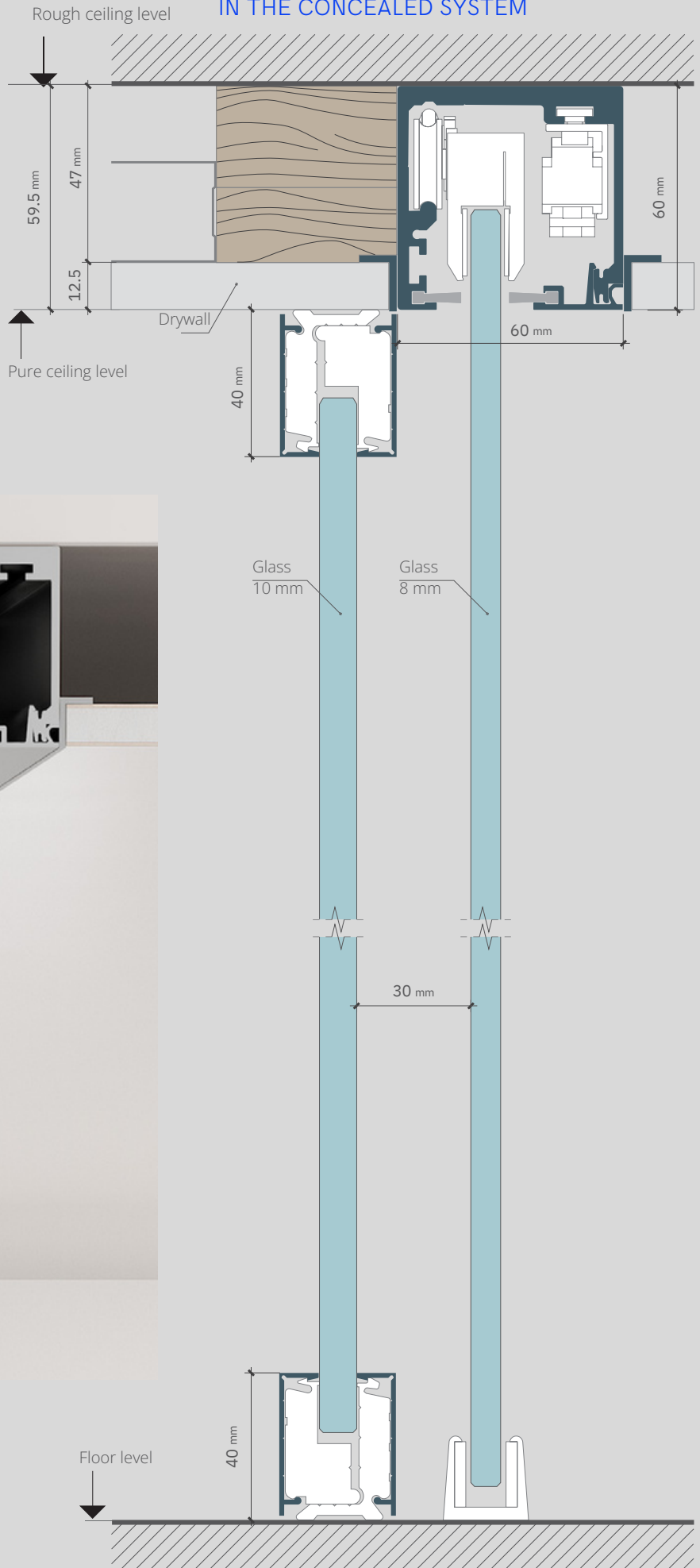

Hafele SLIDO CLASSIC - F system





Hafele SLIDO CLASSIC - F system

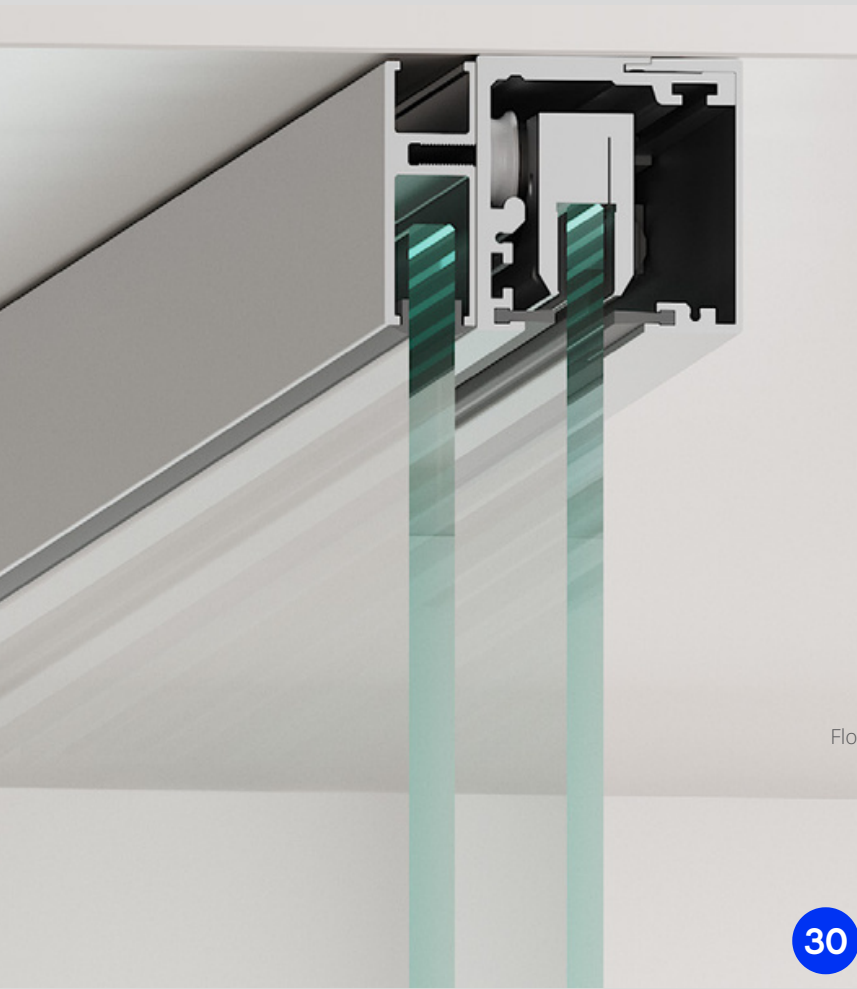
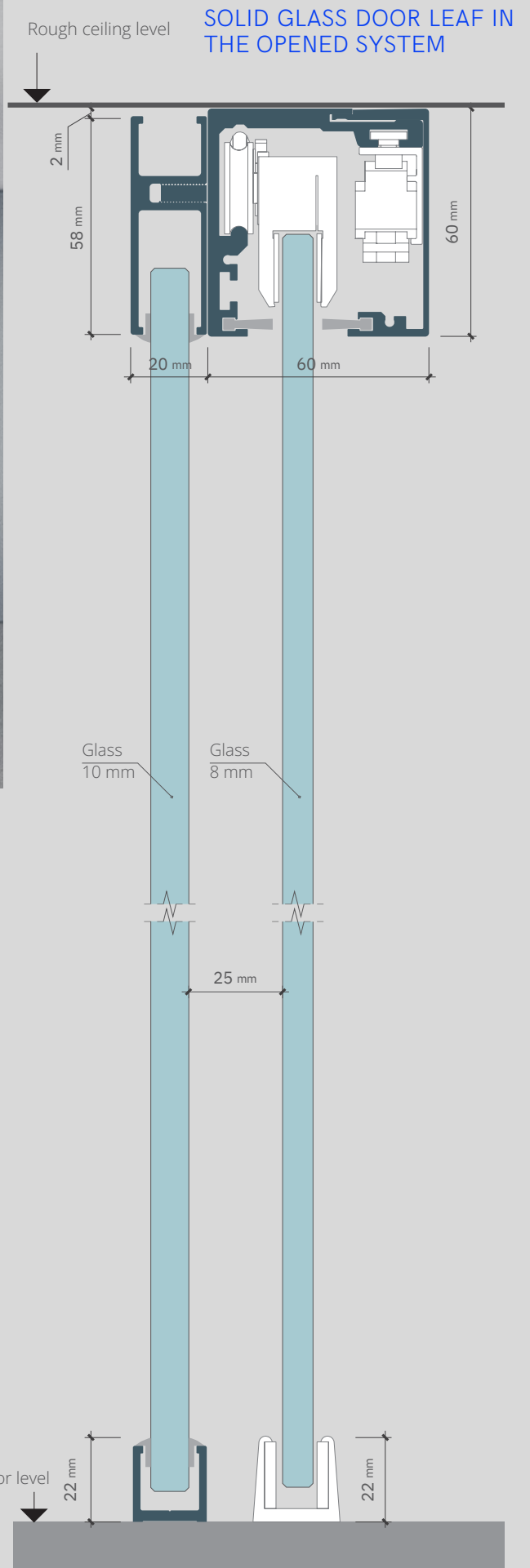

Partition
with full-glass sliding
system

Hafele SLIDO CLASSIC - L system

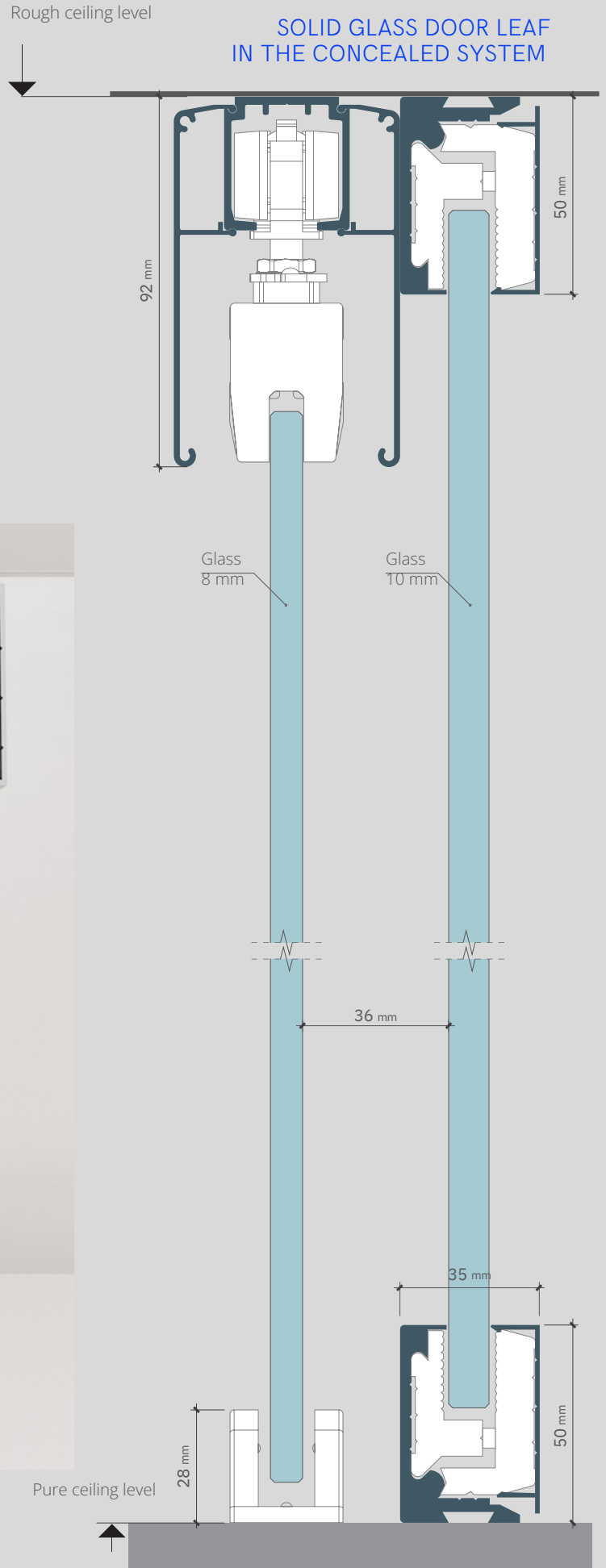
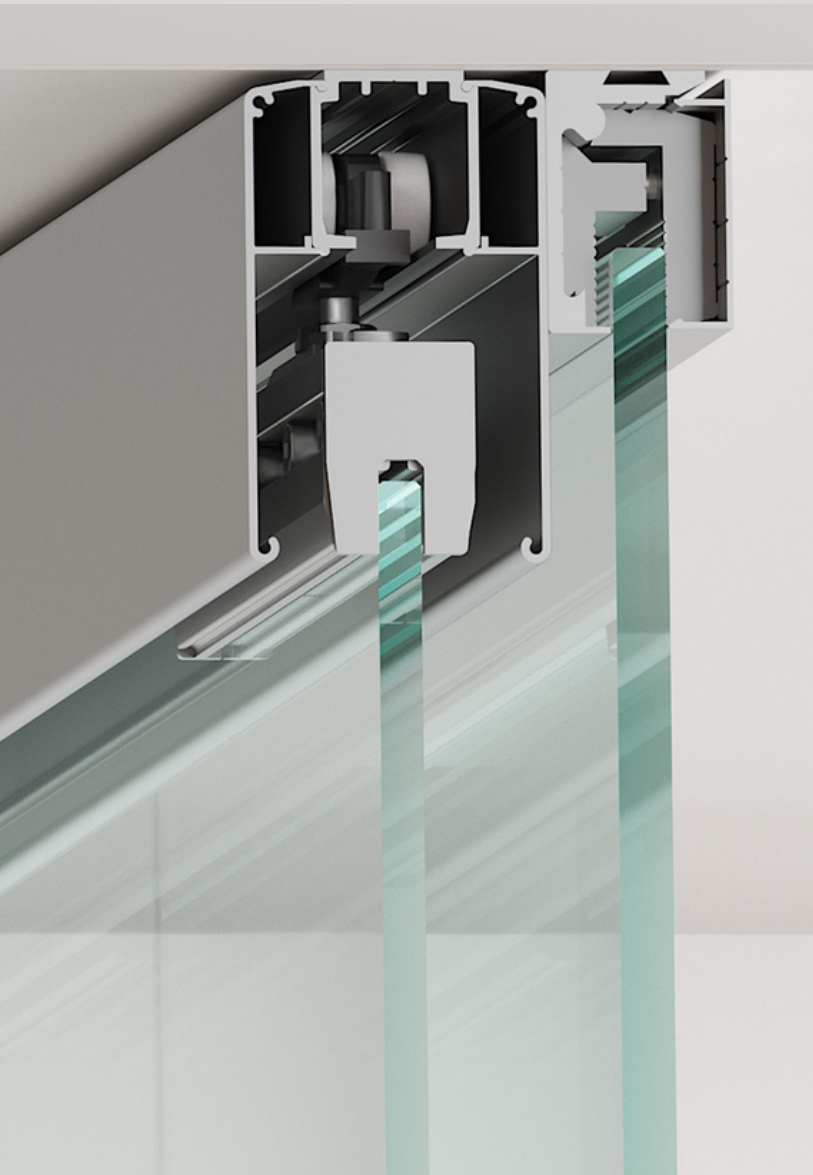



Hafele SLIDO CLASSIC - L system

SOLID GLASS DOOR LEAF IN THE OPENED SYSTEM

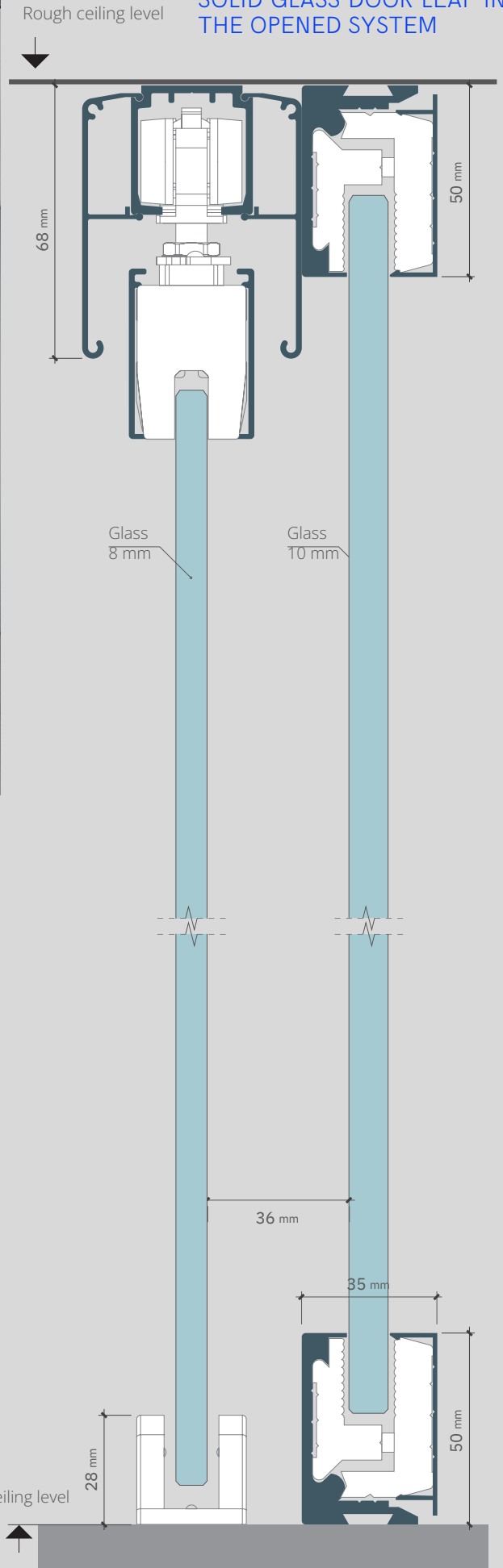

VARIANTS OF THE SWING LEAVES IN THE PARTITIONS

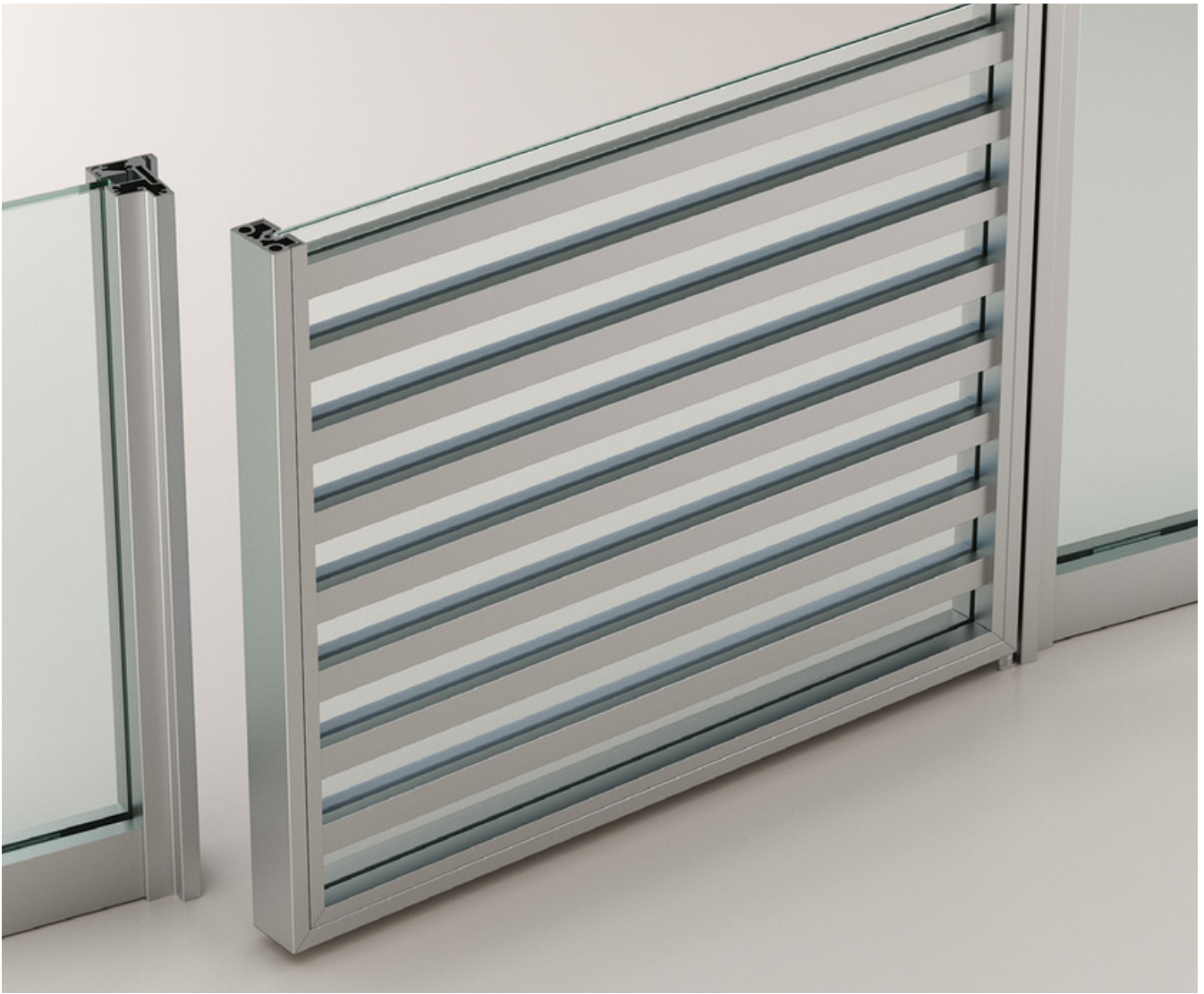

DOOR LEAF IN THE ALU 1 PROFILE /SWING/

1

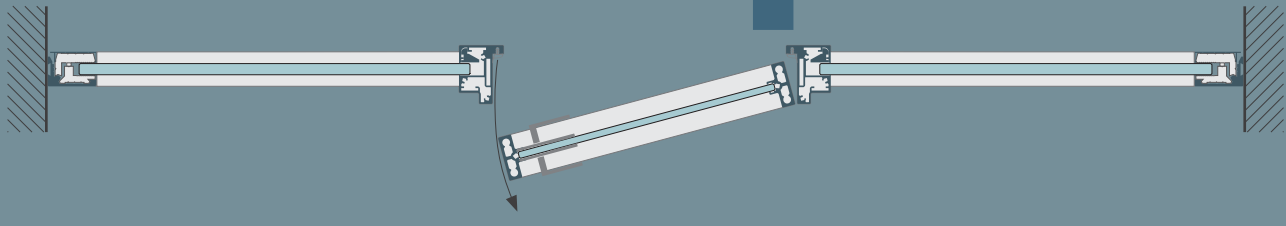

DOOR LEAF IN THE ALU 2 PROFILE /SWING/

2

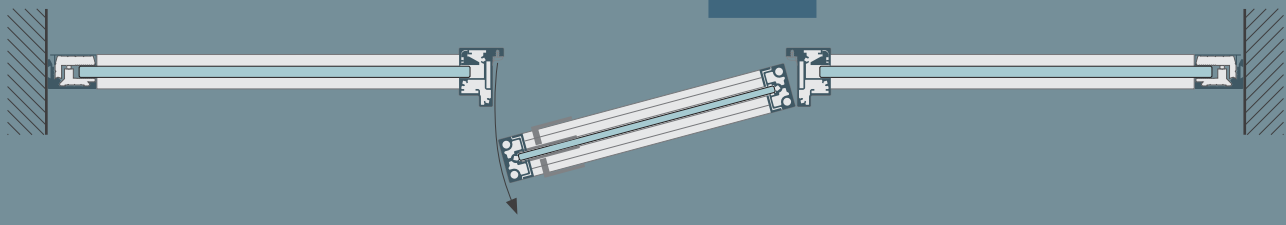

SOLID DOOR LEAF IN THE DOOR JAMB /SWING/

3

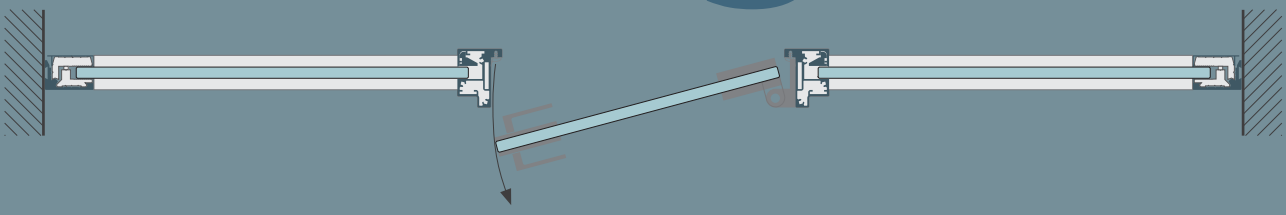

SOLID GLASS DOOR LEAF WITHOUT DOOR JAMB /SWING/

4

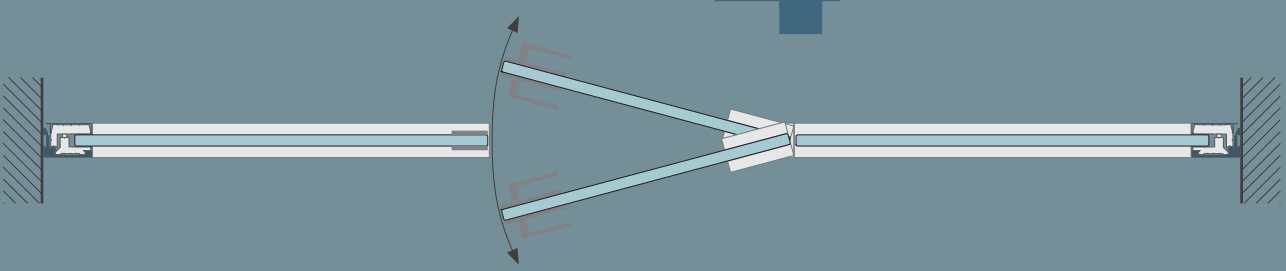

1. DOOR LEAF IN THE ALU 1 PROFILE

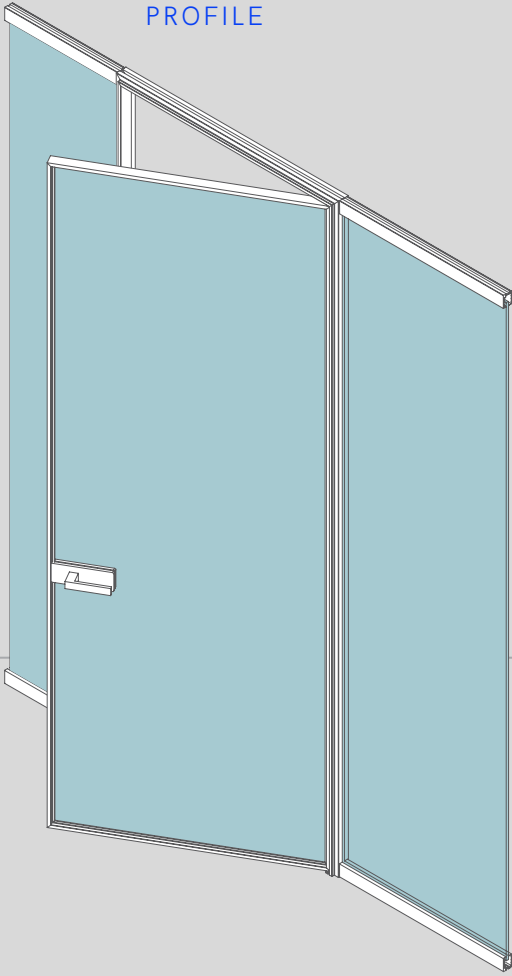

2. DOOR LEAF IN THE ALU 2 PROFILE WITH GLAZING BARS

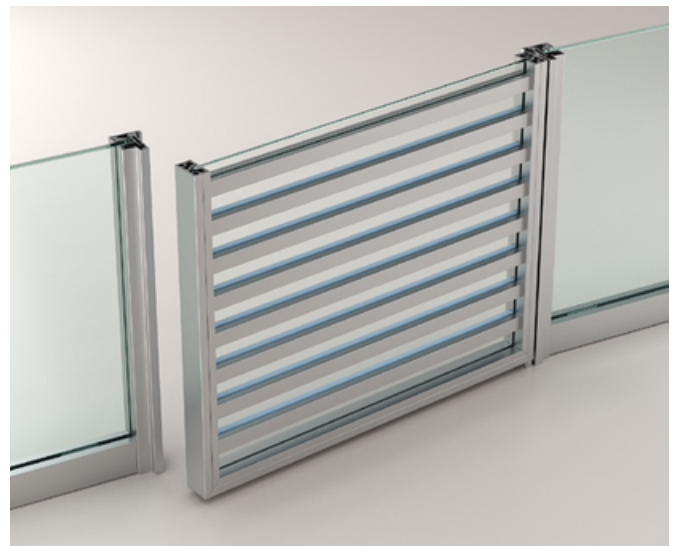
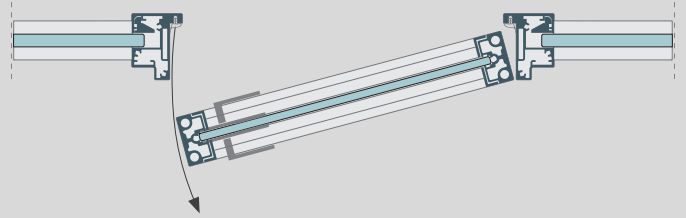
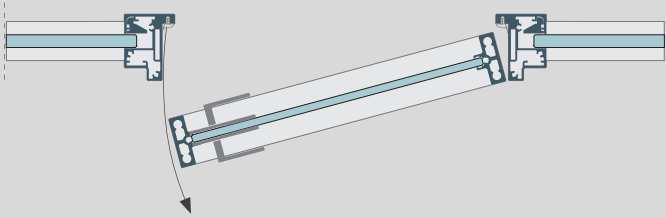
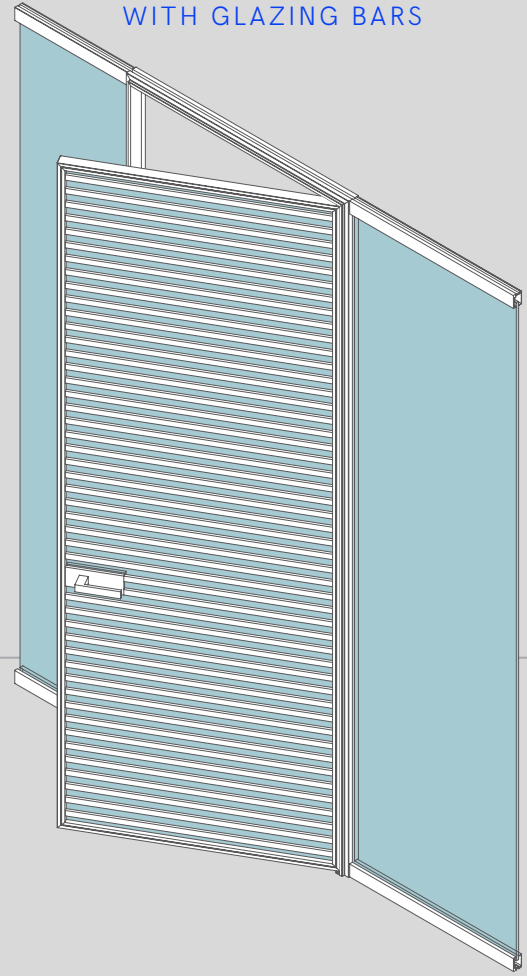

3. SOLID DOOR LEAF WITH JAMB

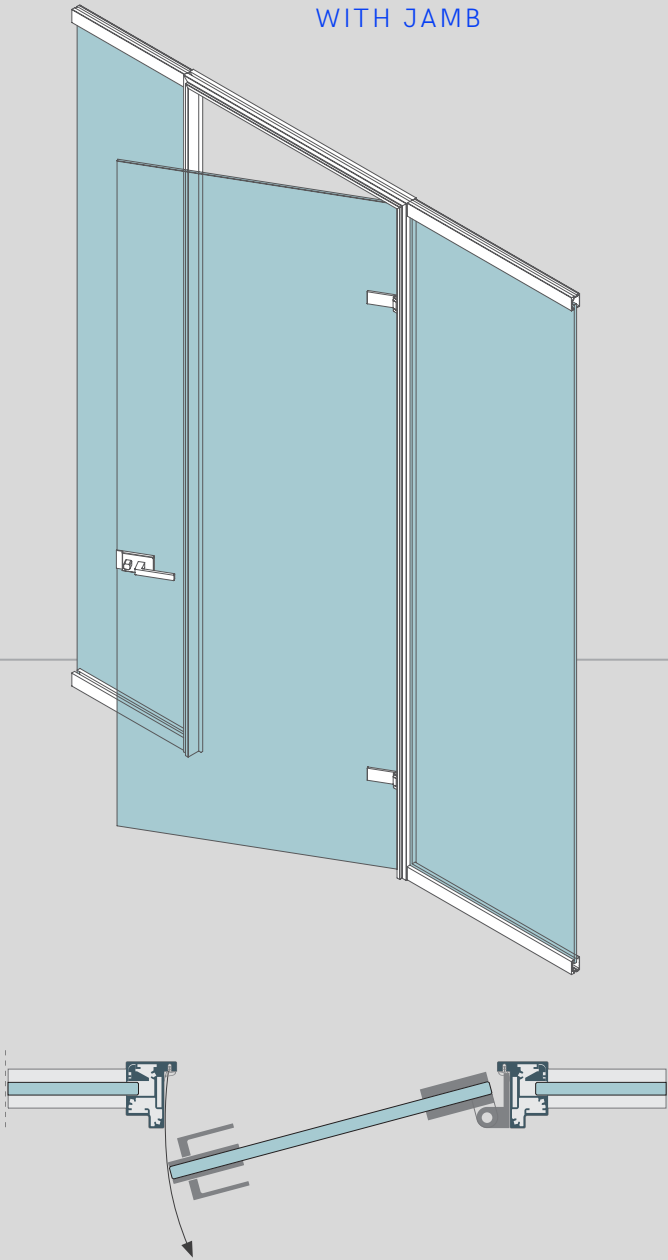

4. SOLID DOOR LEAF WITHOUT JAMB

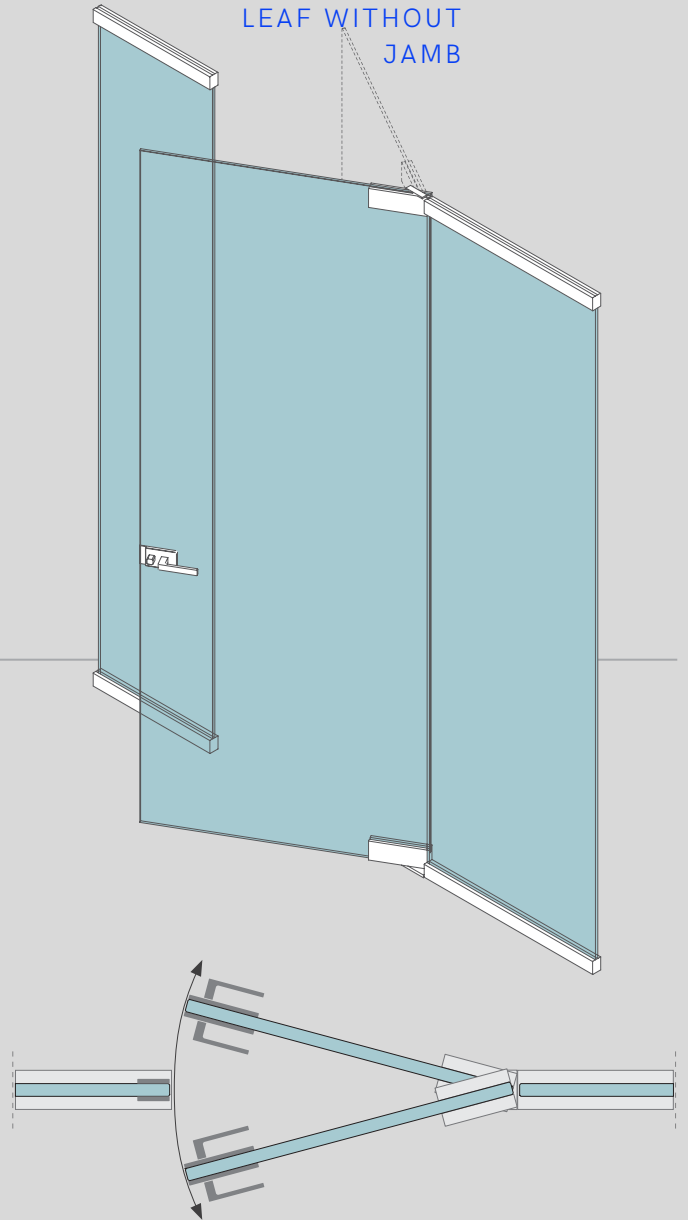

VARIANTS OF THE SLIDING DOOR LEAVES IN THE PARTITIONS

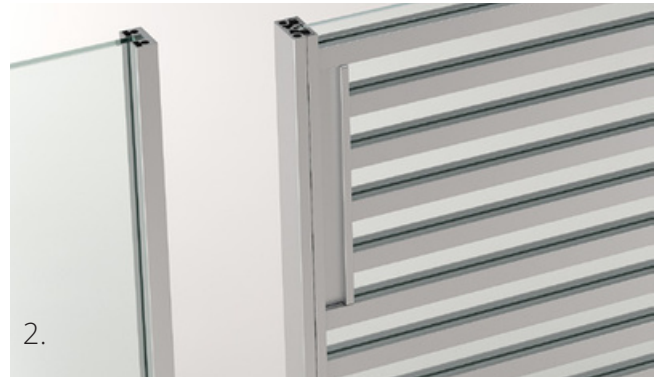

ALUDOORS DOOR LEAF
/SLIDING/

1

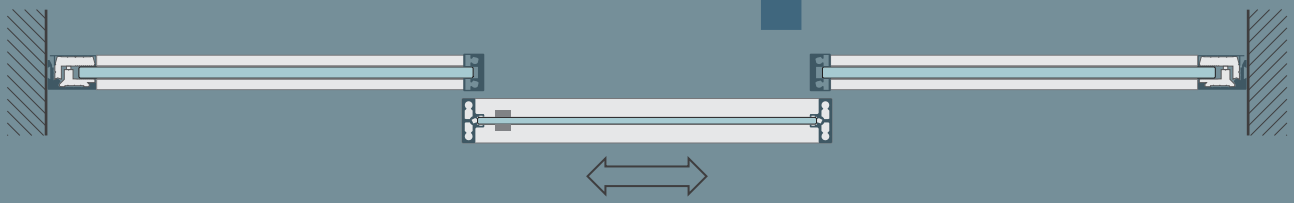

ALU 2 DOOR LEAF WITH THE GLAZING BARS
/SLIDING/

2

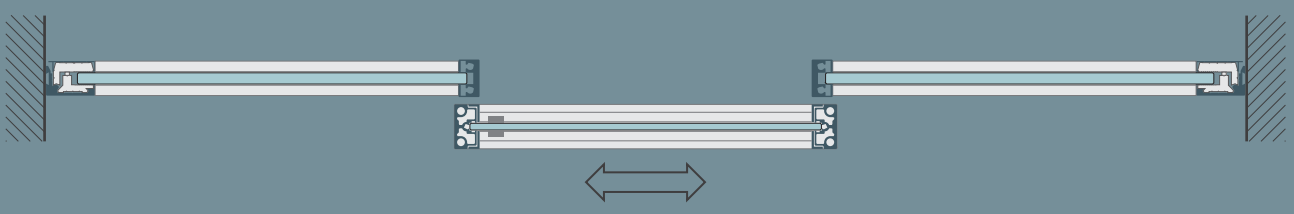

FULL-GLASS DOOR LEAF
/SLIDING/

3



FULL-GLASS DOOR LEAF
/SLIDING/

4

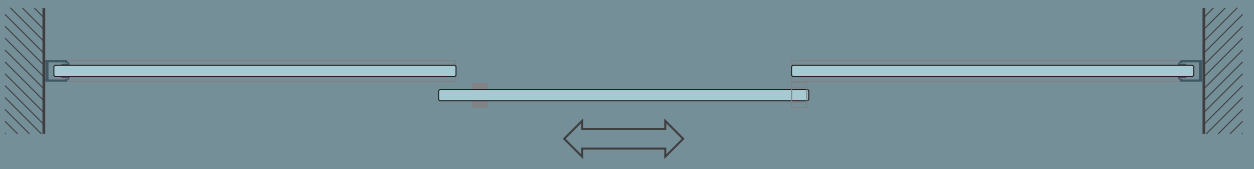

1. DOOR LEAF PROFILE ALU1

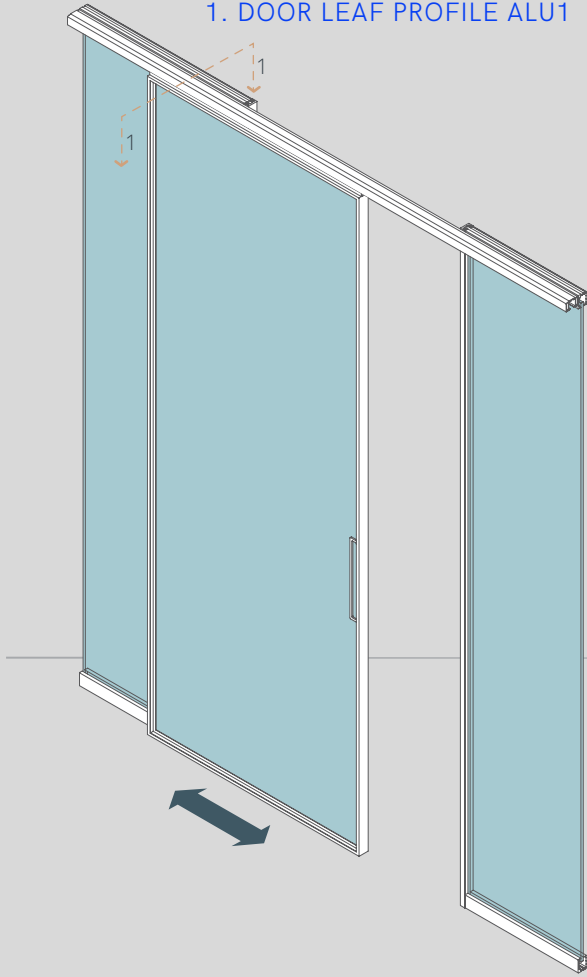

2. DOOR LEAF PROFILE ALU2 WITH THE GLAZING BARS

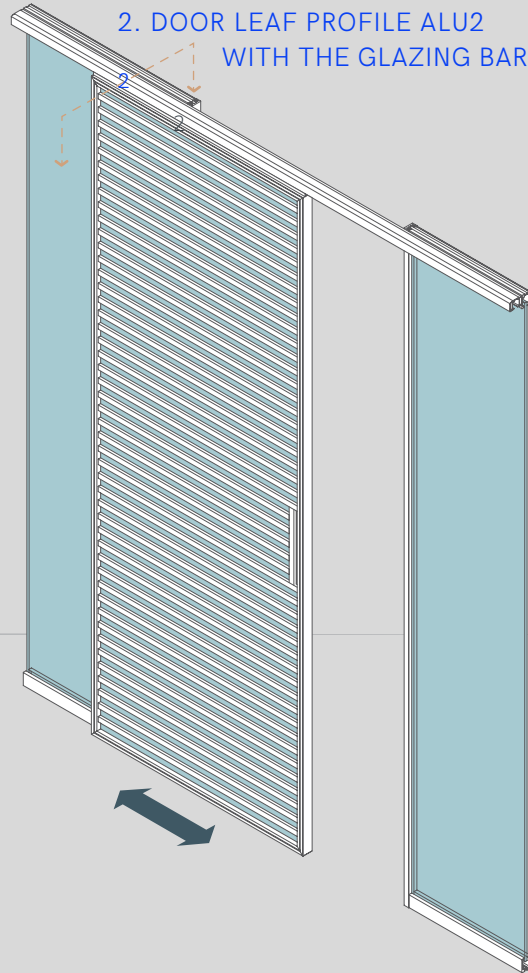

SECTION 1-1

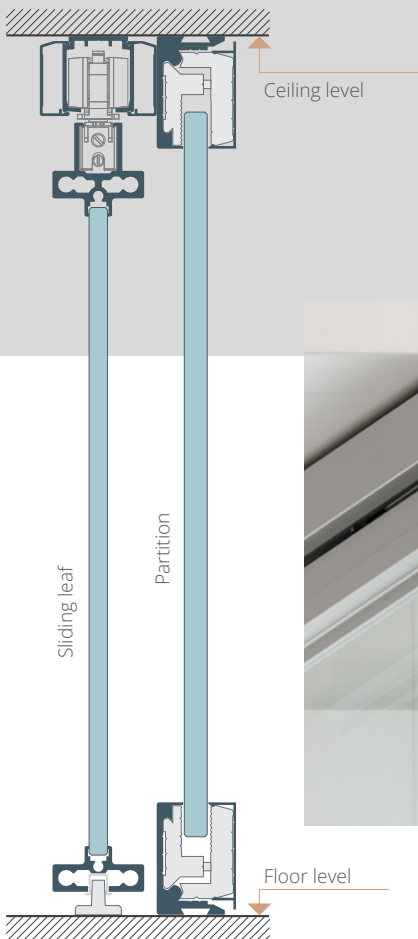

SECTION 2-2

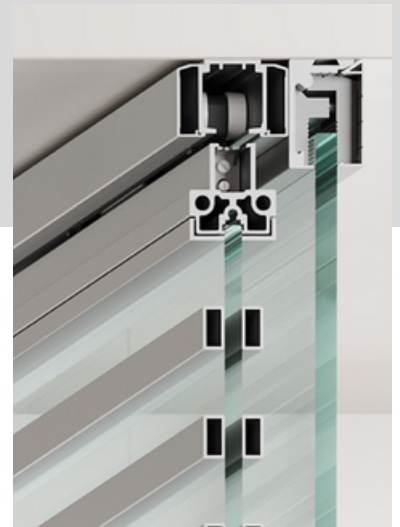
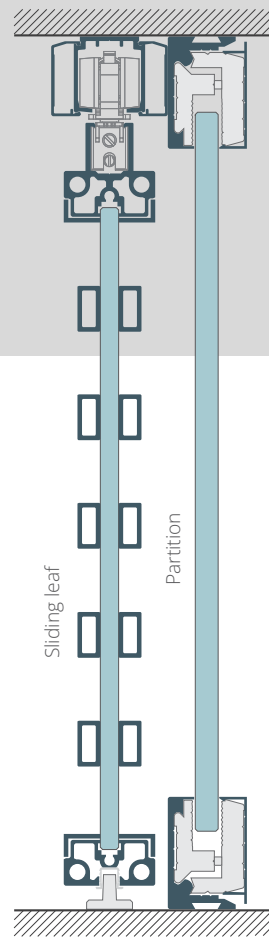

3. FULL-GLASS DOOR LEAF L SYSTEM

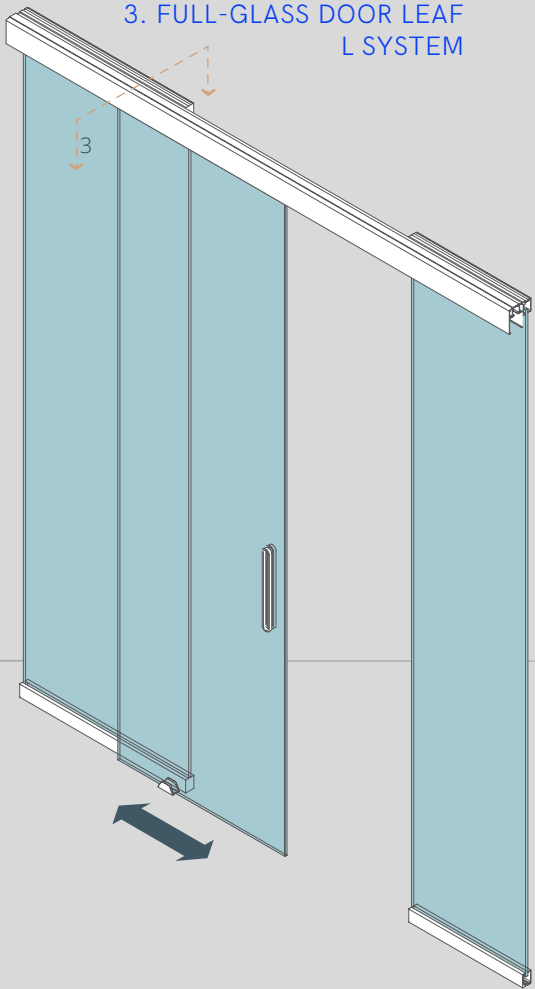

4. FULL-GLASS DOOR LEAF F SYSTEM

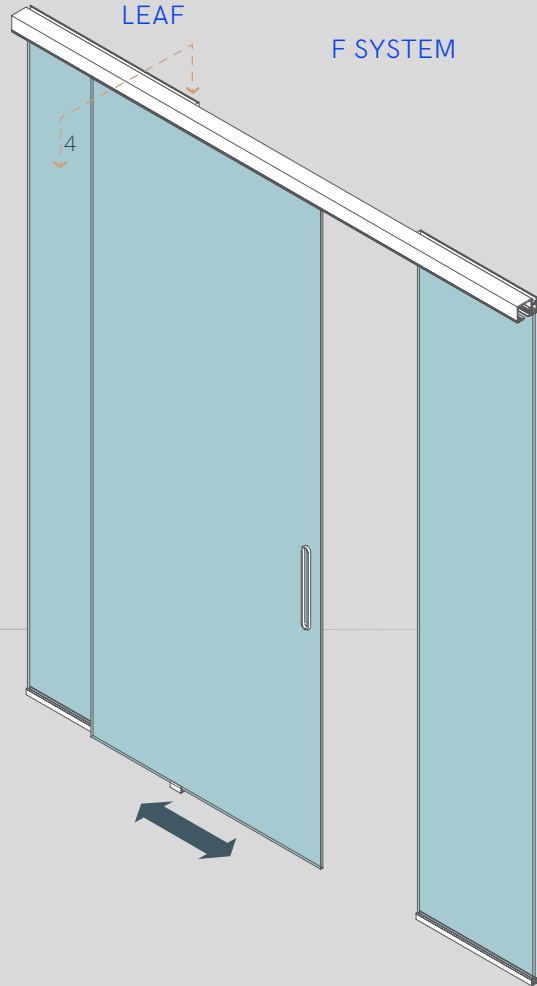

SECTION 3-3

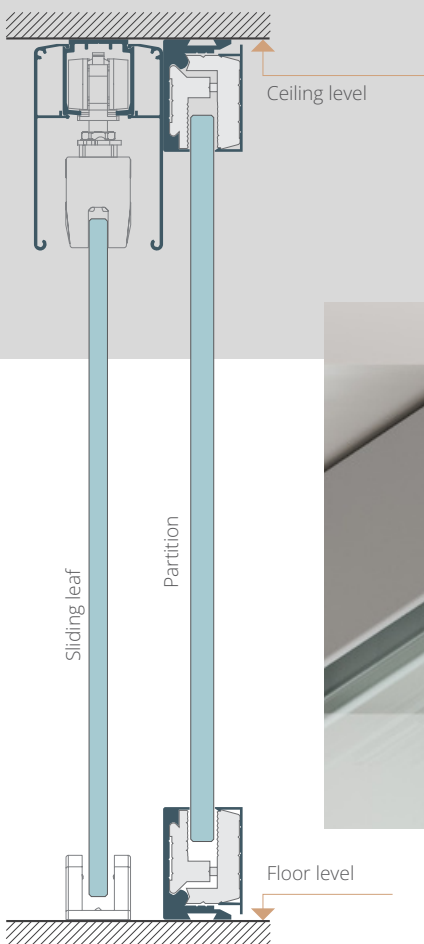

SECTION 4-4

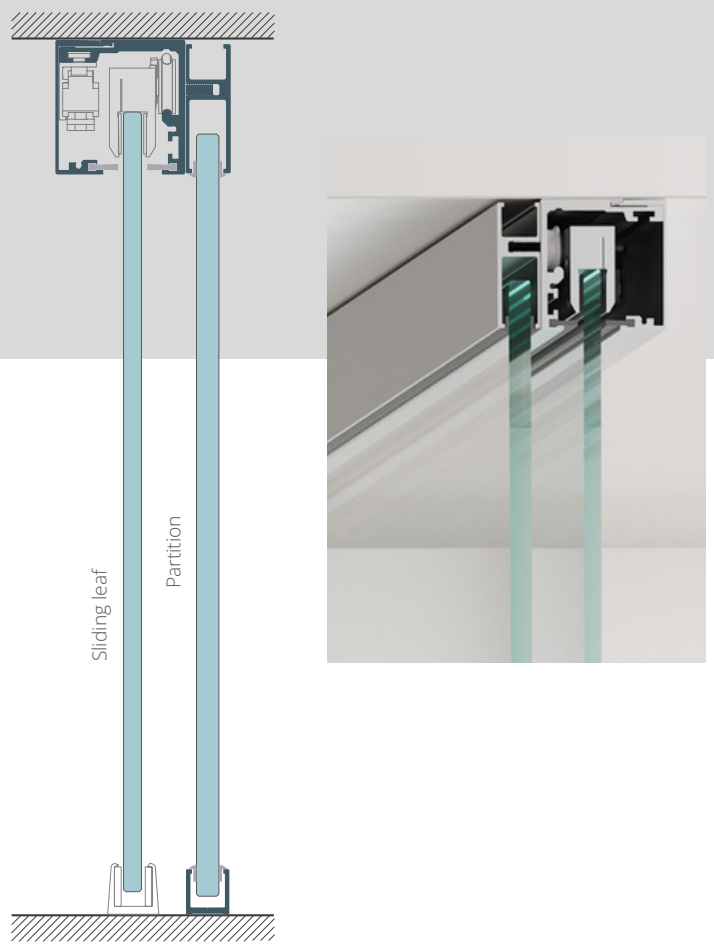

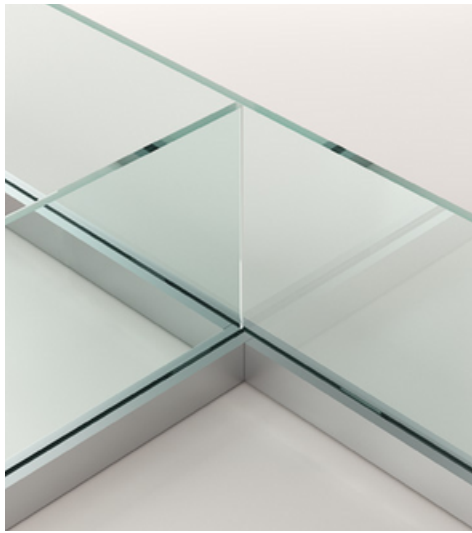

ANODIZED

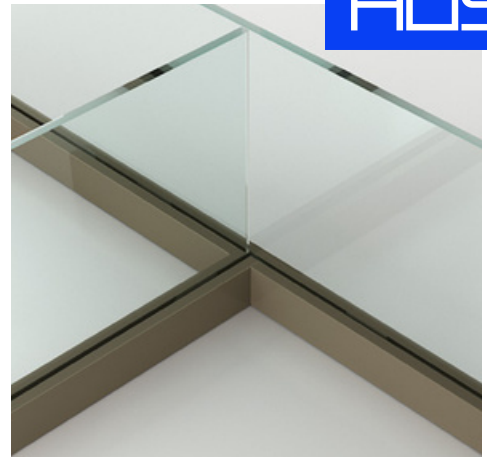

BRONZE

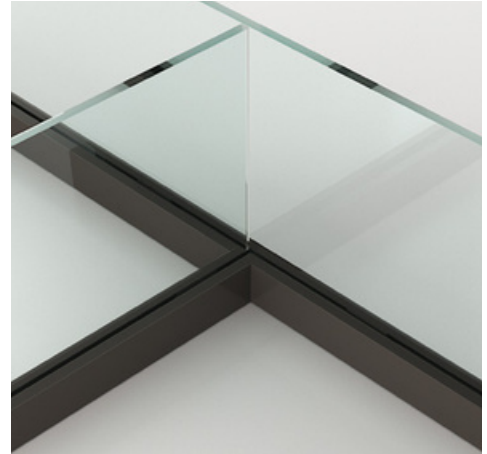

BROWN

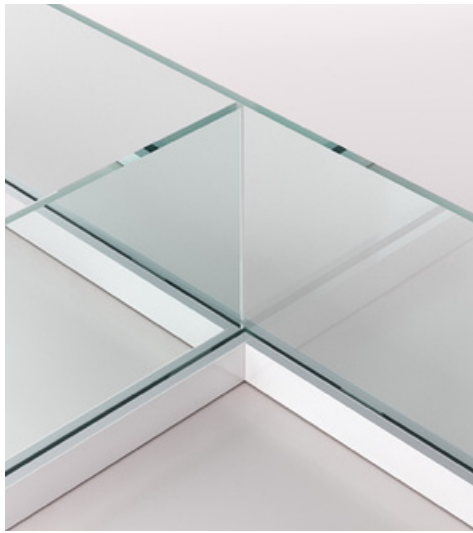

WHITE

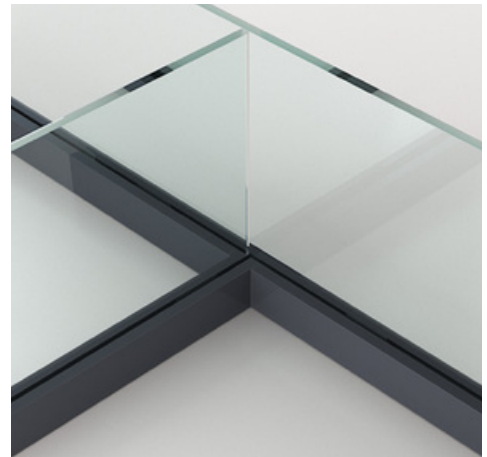

GRAPHITE

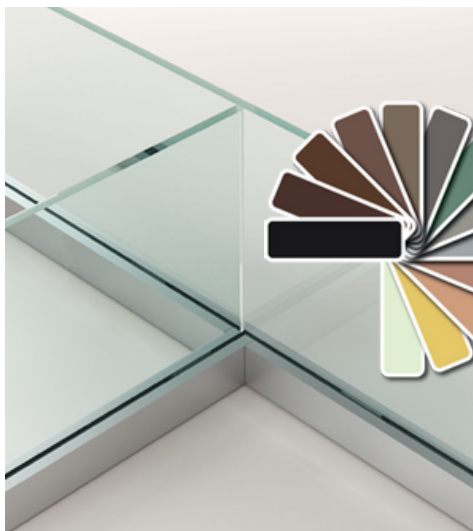

RAL COLOR

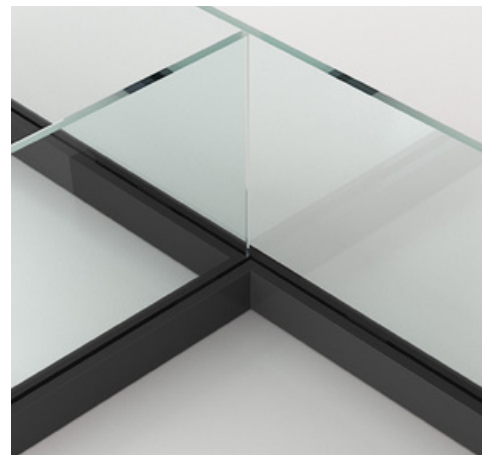

BLACK

PROFILE COLOR

TRANSPARENT GLASS 6/8/10 MM

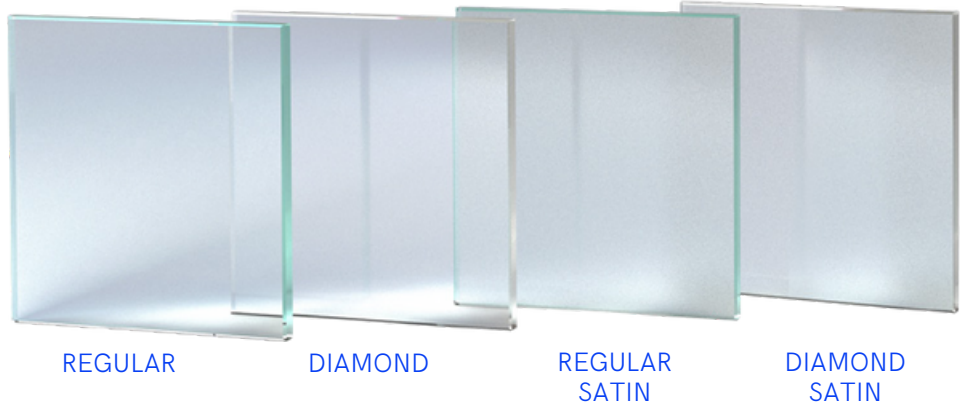

TINTED GLASS 6/8/10 MM

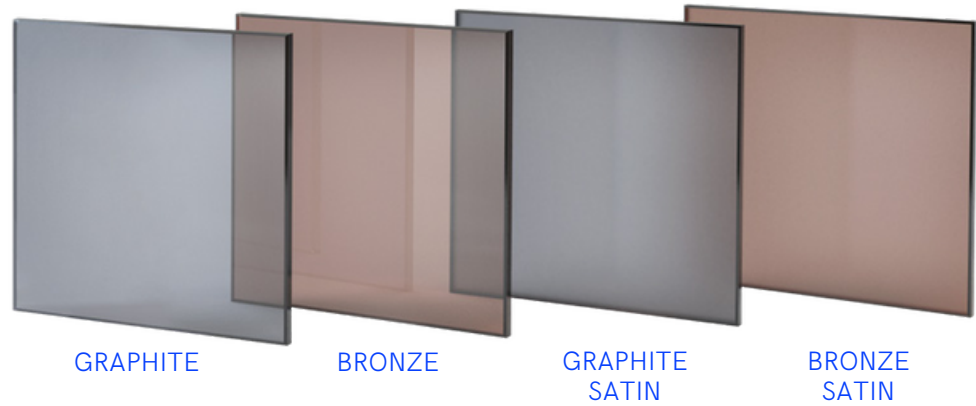

TRIPLEX 4+4 MM



HOSET



044 744 1465



myynti@hose.fi



MiiA Rakennus Oy,



Akerlundinkatu 11A, 33100 Tampere



Open: by appointment



Call center daily from 9:00 to 22:00

CLICK
ME



SCAN
ME

