

Retractable mechanisms



The assortment offered by different manufacturers is quite complex.

But we will be happy to help you figure it out and choose the best for you.

Only the best for you

HOSET



Content

Muller 3 

Muller concealed mounting 4 

Muller Profi Line 5 

Hafele 6 

Metal Box 500/118 7 

Damper for Metal Box
plastic gray 16 mm 8 

Blum 9 

Metal Box K 10 

**No need to save on
accessories** 11 



Muller

The German manufacturer of furniture fittings Muller is an excellent example of the fact that European quality products can be affordable. The hallmark of the company is durability and a wide range of fittings for modern kitchens.

The catalog of Muller kitchen fittings includes soft-close hinges, lifting and locking mechanisms, telescopic rails, pull-out corners, dryers and other kitchen accessories. Silent and smooth operation of all mechanisms will provide maximum comfort in the operation of furniture.



Müller

Muller concealed mounting

Furniture fittings for concealed installation are a combination of practicality and reliability.

Guides of this type have a number of advantages:

- hidden from view, so they do not spoil the interior;
- prolong the life of the furniture, while maintaining its neat appearance;
- allow you to move boxes easily and silently;
- easily installed inside cabinet for kitchen, nursery or office.



Concealed mounting guides are indispensable in the arrangement of movable furniture elements. A special type of such fittings is guides for flush-mounted drawers, equipped with an ejection mechanism.

High-quality furniture fittings are made of durable materials and make the operation of the furniture convenient.

These products are used for:

- movable shelves in the kitchen;
- drawers without handles in the wardrobe;
- movable elements of a desk, wardrobe in the living room or bedroom.

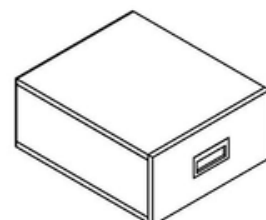
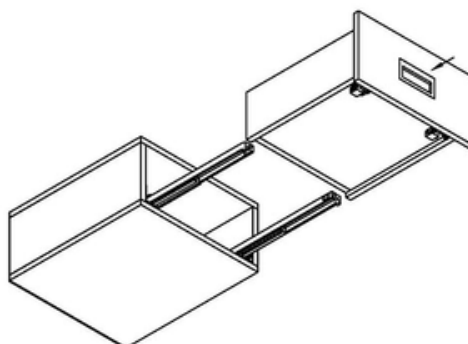
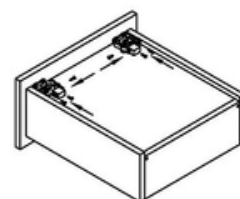
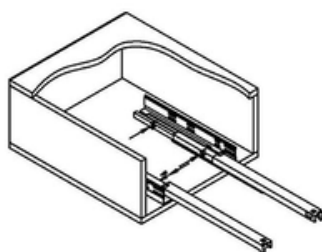

Muller Box profi line

The Muller Box Profi Line system of pull-out drawers is a practical solution that will help organize the storage of things inside the kitchen sections.

The modern design of the sidewalls, the ability to install front panels without a handle make this pull-out system an ideal element for drawers in kitchen sets, bedroom cabinets or office furniture.

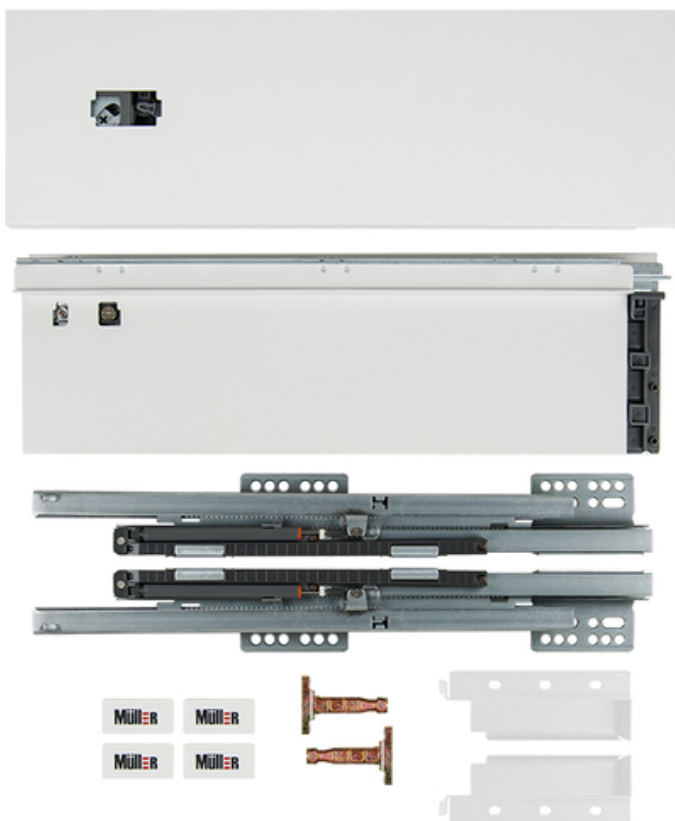

Here everything is thought out to the smallest detail:

- Thin sidewalls 13 mm;
- Universal colors: white and anthracite;
- Different sizes of drawers (length and height);
- Laconic design, which is combined with any facades and countertops;
- Silent movement of guides;
- High operational characteristics.



Hafele

Hafele is one of the world leaders in the production and sale of furniture and joinery fittings.

A wide range of products for every customer, a leading position in the field of fasteners, a reliable quality control system, an extensive worldwide network, a special order processing and delivery service - this is not the whole list of Hafele advantages. The technology applied is zinc alloy die casting (pressure) with a hot compression chamber, plastic injection molding, cold extrusion technology and assembly of parts made of various materials.



HÄFELE

Metal Box 500/118



Metalbox or metal box is an element of kitchen furniture, which is a system of full or partial extension. The design of the metalbox consists of roller guides and steel sidewalls attached to the top of the box.

Metalbox, as a rule, copes with a load of up to 35 kg, has a height of 50 to 150 mm and a length of 300, 350, 400 and 500 mm. In most cases, metalboxes are equipped with closers, which makes their operation much more comfortable.

Metalboxes are functional systems with a number of advantages:

- Save usable space. Drawers have a large capacity.
- Long service life. Due to the fact that metal boxes are made of metal, they last much longer.
- Metalboxes are easy to install.

Among the shortcomings, it can be noted that the boxes with metal boxes cannot be made deep. This problem is usually solved by additional installation of roof rails attached to the rear wall of the facade.



Damper for Metal Box plastic gray 16 mm

Dampers are designed for doors that rise up, open horizontally and slide out. In general, a universal thing. Moreover, it provides the necessary softness when closing. Nothing knocks, no rumbles. And the reason is only in a small, sometimes barely noticeable, damper.



In addition, mechanical dampers can also be bought for rising facade parts. They consist of two or more knees connected by hinges and a brake force adjustment device. If gas springs do not require maintenance during use, then mechanical lifters will have to be periodically lubricated for normal operation.

The principle of operation of the furniture damper is based on the interaction of the rod, pusher and stop. When a certain force is applied to the rod, due to hydraulic processes, it "extinguishes" the force acting on it from the side of the facade.

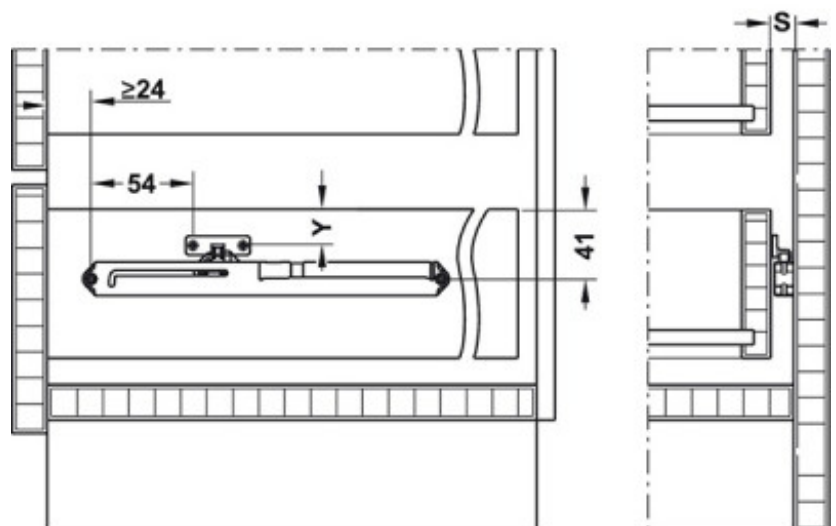

Blum

The Austrian company "Julius Blume GmbH" is known worldwide for innovative furniture fittings. The Bloom system for the kitchen is high-quality lifting mechanisms, hinges, extension and guide systems, dividing systems. All products are distinguished by unsurpassed design and long-term trouble-free operation.

Kitchens with blum fittings provide convenient, silent and easy opening/closing of doors, drawers and doors of the kitchen, thanks to which the operation of the furniture will be as comfortable as possible.



 **blum**

Metal Box K



Metabox is a roller pull-out system of four metal guides, which is mounted on drawers. Side rails act as side walls and can be of different heights and lengths. To increase the capacity of the drawer, the working height can be increased with the help of special extension bars, and the separation systems provide an orderly storage of kitchen utensils. Systems are equipped with closers.

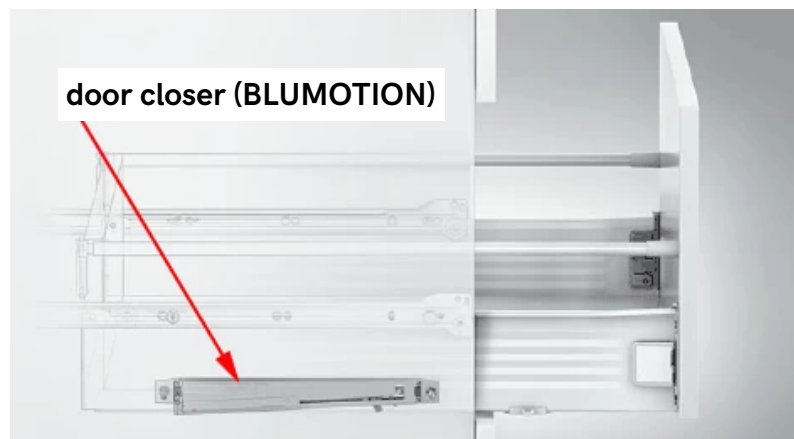

Metaboxes move out on rails for $\frac{3}{4}$ of the length, leaving part of the internal volume limited for access. For simple and convenient operation, the drawers are equipped with closers.

After installing these mechanisms for opening, it is enough to slightly press the facade, after which the sliding element smoothly leaves on the guides.

No need to save on accessories

Fittings are details and mechanisms, well-coordinated work that ensures the comfort and ergonomics of your kitchen. The uniqueness of this type of product lies in the fact that for the time being they remain almost invisible, but the failure of a seemingly invisible part entails consequences equivalent to a universal catastrophe.

In order for the furniture to function properly and bring pleasure, a serious and verified approach to the choice of high-quality fittings, which is completed with each item, is necessary. The strength and durability of your kitchen set directly depends on its reliability, so saving on fittings can cost you dearly.



The quality of products manufactured by these manufacturers has been tested by time and many generations of grateful customers. A distinctive feature of this fitting is a harmonious combination of elegant design and impeccable functionality. Innovative technologies and high-quality modern materials are widely used in production, which are distinguished by strength, wear resistance and unsurpassed performance characteristics.



UP!



HOSET

home

Thank You



CHOOSING YOUR HOME...